



MADE IN THE USA
★
SINCE 1999

SALES TRAINING MANUAL



WELCOME TO WATERSTONE FAUCETS

They said it couldn't be done. That manufacturing in the United States is impossible. "You can't compete!", they say. Well what do "they" know? Waterstone Faucets was up for the challenge. To us, it's important to keep quality manufacturing and jobs in the U.S. where it belongs. Since 1999, we have made it all right here - in our factory in California. We take great pride in being able to say that we are truly Made in the USA.

Since our country's beginning, we have been a land of innovators and dreamers. We were the misfits who were crazy enough to hop on a boat and sail for the New World. America was built on dreams, hard work and the ingenuity of it's people. Our dreams turned into the telephone, the light bulb, TV, the smart phone and put a man on the moon. Our creativity has led to blue jeans, rock and roll, muscle cars and baseball. At **Waterstone**, we love what we do. Our dreamers take great pride in creating a piece of art in the form of a kitchen faucet and calling it their own. The craftsmanship and attention to detail cannot be duplicated anywhere else. That is why our products are so sought after by designers, architects, high end builders, and homeowners that want the best.



OWNERS AND FOUNDERS STEVE, CHRIS AND BOB

Made in the USA is making a comeback. Increased consumer awareness for products made in the United States has risen dramatically. **Waterstone** founder Chris Kuran, a Naval Academy graduate and former Marine, is determined to keep the dream here at home. Chris, his wife, four children and Zoey the dog were born and raised right here in sunny Southern California. Why would we go anywhere else? We want to put people to work. American manufacturing jobs are important and have a positive impact on the U.S. economy. We admit it isn't easy. It's tough, but we found a way to create record sales every year. This led to a building expansion and more importantly - more workers! It can be done and we shouldn't let anyone tell us otherwise. That dream is still alive and **Waterstone** is determined to help Americans get there.

So, when they say it can't be done, they might be giving up on the American Dream. They say overseas manufacturing is good enough. Well, good enough doesn't cut it with us. You just cannot create a quality product 5000 miles away. Everyday, our team arrives to work from the local neighborhoods and communities. They grab some coffee, roll up the sleeves and get their hands dirty. No lattes here. We love what we do and it shows in our faucets. Our faucets are built to last forever. We guarantee it!

Thank you for your support.
The Waterstone Team

THE HISTORY OF WATERSTONE

Waterstone Faucets was founded in 1999 by Chris Kuran. At its' inception, the company primarily provided top quality parts and finished components to large manufacturers that made and sold drinking water filtration systems.

As the news of Waterstone's quality parts and timely deliveries spread throughout the industry, customers began requesting that Waterstone provide small institutional drinking water faucets in custom finishes.

Recognizing these requests as a niche opportunity, Waterstone decided to change course and begin the production of high quality Filtration Faucets in numerous finishes to match the higher end kitchen faucets that were being sold for designer kitchens.

Waterstone then designed and developed its own line of decorative Filtration Faucets using only the best materials and finishes available. Utilizing the experience of selling certified products to the Water Quality system manufacturers, Waterstone had already created a highly efficient manufacturing system that could make anything it could design while maintaining the highest certifiable quality.

In 2002 Waterstone launched its first line of decorative Filtration Faucets and chose to market and sell these products through trained and qualified Kitchen and Bath showrooms throughout North America. Waterstone successfully changed direction from a manufacturer of Water Quality components to a niche faucet company.

The program was a huge success, and the dealers began requesting other niche products. By this time, Waterstone Faucets was selling its filtration faucet program in all 50 states and Canada. By designing, engineering, manufacturing, finishing, assembling, testing and packing all products at our manufacturing facility in California, Waterstone had grown in size and had added production capacity in preparation for its next big change. That change happened in 2005, again with the continued encouragement of its customers.

Waterstone made the decision to add Kitchen Faucets and related items to its product offerings. In typical fashion, Waterstone started from the ground up and designed, developed and engineered a full line of Kitchen Faucet products to match its Filtration Faucets. The guiding focus and desire was to manufacture products that would match the uniqueness of the original ground breaking Filtration Faucet designs.



1999 - OUR FIRST FAUCET



***TODAY - TOWSON HOT AND COLD
FILTRATION FAUCET***

THE HISTORY OF WATERSTONE

WATERSTONE FAUCET SUITES

Over the course of time Waterstone has crafted six complete one of a kind Kitchen “Suites” of products. Each “Suite” has its own look, feel and style that lend itself to a specific decorative kitchen design. Waterstone’s concept is to create a matching ensemble of products that cover all the faucetry needs of one’s own kitchen. From the patented Gantry® Faucets to the 14 other matching items in each style, our faucet “Suites” provide everything for the kitchen. Available in **29 finishes plus solid stainless steel**, Waterstone provides its customers and their customers the ability to purchase matching products from a single source.

In 2010 Waterstone developed and introduced the industry’s first Positive Lock Pulldown Kitchen Faucet (**PLP**)®. It is available in extended reach, standard reach and prep sizes. Each can be ordered as the faucet only or as a **2, 3 or 4 piece Suite**. The **PLP**® is available in all finishes plus solid stainless steel.

As the kitchen has evolved into a central gathering area in the home for family and friends the number of choices of faucetry has expanded to keep pace with new and spacious kitchen layouts and designs.



SUITE STORY

Today there are more individual faucetry items available to perform specific functions. The Gantry, Bridge, Pulldown, Kitchen, Prep, Bar, Filtration and Potfiller Faucets are used individually and in conjunction with each other. The addition of accessory items such as Side Sprays, Soap/Lotion Dispensers, Decorative Air Switches, Air Gaps, Escutcheon Plates, Decorative Hole Covers and matching Decorative Cabinet Hardware have provided the homeowner with a complete array of products for this new "living area" of the home.

When building a new home or remodeling, the homeowner is confronted with many decisions. The kitchen offers the opportunity for personal expression and taste. With so many different faucetry items available it is important to coordinate all of the choices in design style and finish. Matching or "Suiting" all of these elements is the obvious answer. However, **NOBODY** but Waterstone Faucets has embraced and resolved this issue! Waterstone Faucets is the only American designed, engineered and manufactured product offering that "Suites" your kitchen. Every type of faucet and all accessory items are coordinated to match or "Suite" with each other.

The three Traditional design styles are offered in solid brass construction. The three Contemporary design styles are offered in solid brass and solid stainless steel construction. All offerings are available in **30 finishes plus solid stainless steel**. That's true "Suiting" of the kitchen. We invite you to join the growing family of customers who have chosen to "Suite" their kitchen faucetry with Waterstone products. We know you'll be glad you did as you have your next gathering in the #1 room in the home... your kitchen.

Waterstone Faucets future is bright. We hope you will join us in our pursuit of excellence in design, production and service by putting a Waterstone Faucet in your home!

ANNAPOLIS



TAKE A FACTORY TOUR

FROM BRASS TO SINK

We do it all, right here in California. Our faucets come through the back door as solid brass or stainless steel and leave as exquisite faucets and accessories that highlight your kitchen sink area. Follow the manufacturing process through our factory and get a glimpse of how we create **American Made** kitchen faucets and accessories by blending art and technology.



WATERSTONE FACTORY - MURRIETA, CA





CORPORATE AND SALES TEAMS



CORPORATE TEAM INFO

41180 Raintree Court / Murrieta, CA 92562
 Toll Free: 1-888-304-0660 / Fax: 951-304-0525
 Hours: 7:30am to 5:00pm PST

| NAME | TITLE | PHONE/EXT. | EMAIL |
|---|---|------------|-----------------------------|
| Chris Kuran | President | 300 | chris@waterstoneco.com |
| Steve Kliewer | VP of Manufacturing | 301 | steve@waterstoneco.com |
| CUSTOMER SERVICE | | | |
| Kathy Johnson-Audette | Customer Service Manager | 200 | kathyj@waterstoneco.com |
| Brandy Walker | Customer Service Rep | 211 | brandyw@waterstoneco.com |
| Maritza Olmos | Customer Service Rep | 202 | maritzao@waterstoneco.com |
| Debbie Culver | Customer Service Technical Rep | 212 | debbiec@waterstoneco.com |
| John Millard | Technical Support | 201 | JMillard@waterstoneco.com |
| ACCOUNTING | | | |
| Pam Donnelly | Purchasing Manager/Credit and Collections Manager | 603 | pam@waterstoneco.com |
| James Li | Controller | 302 | accounting@waterstoneco.com |
| PRODUCTION / PRODUCTION PLANNING | | | |
| Don Stauty | Production Control & Planning Supervisor | 304 | DonaldS@waterstoneco.com |
| Bill Serrano | Production Manager | 317 | BSerrano@waterstoneco.com |
| Richard Kumler | CNC Production Manager | 316 | RKumler@waterstoneco.com |
| Kathleen Lank | Senior Production Planner | 322 | KathleenL@waterstoneco.com. |
| MARKETING | | | |
| Mike Zinniger | Creative Director | 309 | mikez@waterstoneco.com |

SALES TEAM INFO

| NAME | TITLE | ADDRESS | PHONE/EXT. | EMAIL |
|---------------|--|--|--|----------------------------|
| Steve West | Central Region Sales Manager | 39627 North 5th Ave. Phoenix, AZ 85086 | Office (505) 217-8788 Cell (505) 217-8788 Fax (866) 950-4265 | steve@waterstoneco.com |
| Chris Bica | West Region Sales Manager | 32937 Rose Avenue Lake Elsinore, CA 92530 | Office (626) 523-9653 Cell (626) 523-9653 Fax (951) 304-0525 | cbica@waterstoneco.com |
| Jodi Vallejos | East Region Sales Manager | | Cell (602) 679-0812 | jvallejos@waterstoneco.com |
| Efrain Flores | Southern California Territory Manager | 7445 Shadow Grove Ct. Corona, CA 92881 | Cell (562) 397-6581 Fax (951) 304-0525 | efrain@waterstoneco.com |
| Darcy Kuran | Southern California Territory Manager | 3794 Paseo de Olivios Fallbrook, CA 92028 | Cell (760) 212-7332 Fax (951) 304-0525 | darcy@waterstoneco.com |
| David Rush | Illinois & Wisconsin Territory Manager | 9575 Hickory Lane St. John, IN 46373 | Cell (219) 670-9996 Fax (219) 627-1184 | drush@waterstoneco.com |
| Brian Gallop | NY Metro/New Jersey Territory Manager | 77 Mt. Salem Road Wantage, NJ 07461 | Cell (602) 790-4445 | bgallop@waterstoneco.com |
| Nikki Salerno | Florida Territory Manager | | Cell (407) 457-8757 | nsalerno@waterstoneco.com |

POLICIES AND PROCEDURES

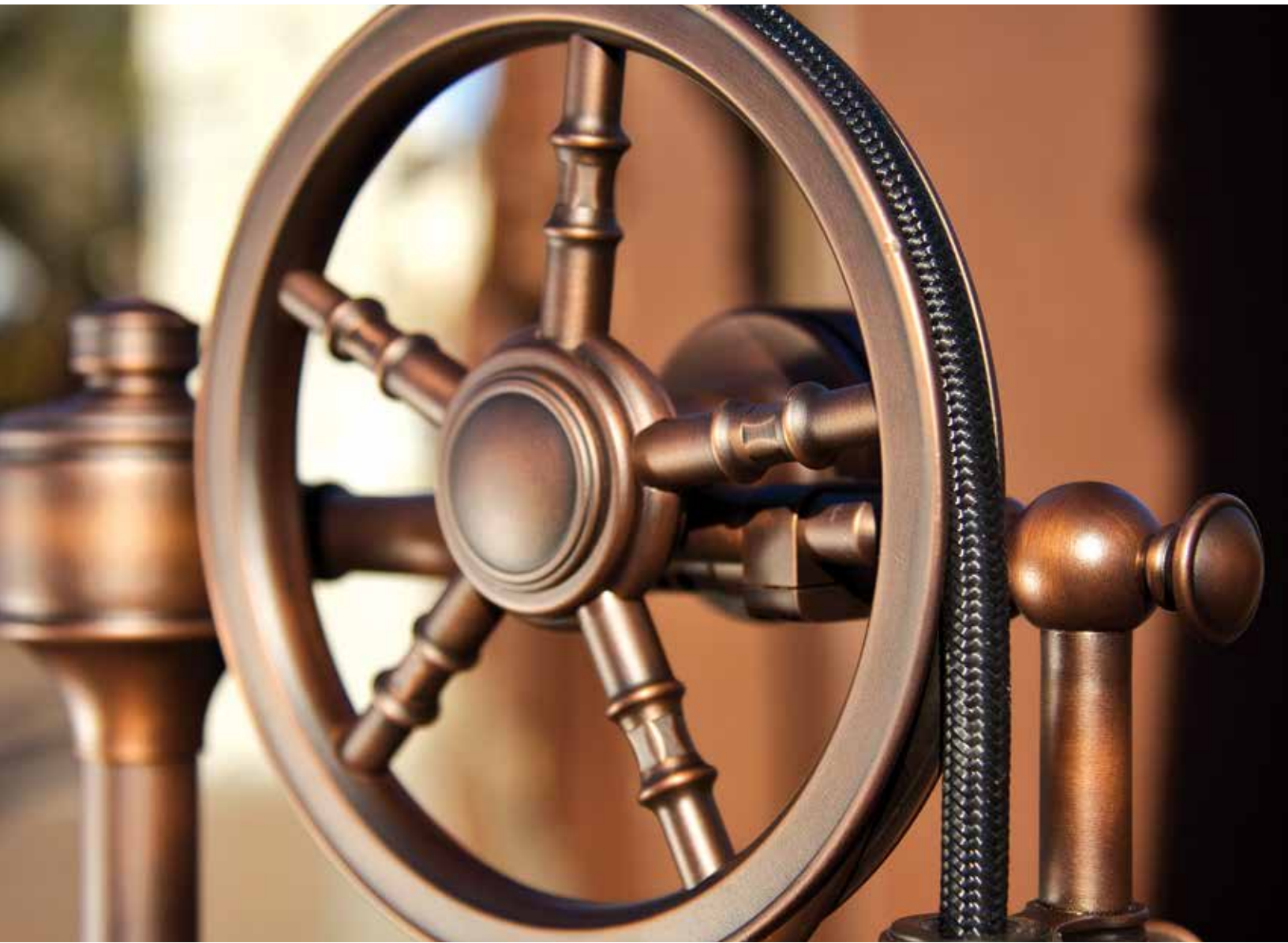

TERMS AND CONDITIONS

PAYMENT TERMS:

Early payments receive a 1% discount if received within 10 days DOI. Regular payment terms are Net 30 days, DOI with credit approval (1% Discount not available for Credit Card Payments). Waterstone also accepts payments made by VISA, MASTERCARD, AMERICAN EXPRESS and DISCOVER credit cards. Waterstone shall have the option to charge 1 ½% interest on all past due accounts monthly. In the event of legal action to collect any past due amounts, the buyer shall be responsible for all attorney Collection fees, court costs or other fees reasonable and proper for such collection(s).

FREIGHT:

All orders are F.O.B. Murrieta, CA. In general, all goods are shipped UPS ground unless otherwise specified by the customers Purchase Order. Shipments that can be consolidated to a pallet size may be shipped via common carrier. Customer preferred shippers or method of shipment will be accommodated providing such preference is listed on the customers Purchase Order.

PRICING:

All prices and terms are subject to change without notice.

CLAIMS:

All claims for shortages or damages must be made within ten (10) days from receipt of merchandise. Claims for merchandise delivered damaged must be filed with the delivery carrier within 7 days. Request an immediate inspection by the carrier.

RETURNS:

All returns are subject to the terms and conditions of the Waterstone warranty. A RETURNED GOODS AUTHORIZATION number (RGA #) must be obtained by the customer from the Waterstone Customer Care Department prior to any merchandise return. The RGA # must appear on the return packing slip/document and a copy of the approved pending RGA form must be in the box with the returned unit. Upon inspection, Waterstone, at its option will either repair or replace the item if the defect falls under the guidelines of the warranty. New, unused and sealed merchandise in its original packaging of current design accepted by the Company for return is subject to a 35% restocking charge. If the product returned is damaged by the recipient or damaged in transit for return, Waterstone has the right to rescind the restock fee and charge up to the full purchase price of the unit. All credits provided for returned product or otherwise are only valid for 90 days from date of approval and issue by Waterstone. If unused by the recipient after 90 days the credit is null and void, and the RGA product will not be returned. Credits can only be used for Waterstone merchandise.

MINIMUM ORDER:

Order minimum is \$ 50.00 on open account.

DEFAULT:

If a customer is in default under any order of contract with Waterstone, or if Waterstone at any time shall not be satisfied with its customer's financial condition or responsibility, Waterstone shall have the right, without prejudice, to legal remedy including suspending deliveries until such default or condition is remedied.

TITLE:

All merchandise is sold subject to these conditions and shall remain the property of Waterstone until paid for in full, with the provision that all risk of loss or damage to merchandise is assumed by the customer.

ORDER FULFILLMENT POLICY

1. The customer's order will be entered into the order fulfillment system on the day the order is received, providing the order is received by 2pm Pacific Standard Time.
2. An order confirmation will be faxed or emailed to the customer within one working day of the entry of the order into the order fulfillment system. The order confirmation will contain anticipated ship date information and a listing of all items and the customer's cost pricing of these items.
3. The factory will endeavor to ship all orders received as quickly and completely as possible in a single shipment.
4. The factory will ship a customer's order complete whenever the customer places such a request in the body of their purchase order. Without this specific written request, Waterstone will ship partial shipments as they become available.

LIFETIME FUNCTIONAL WARRANTY

All Waterstone products manufactured by Waterstone carry a LIMITED LIFETIME GUARANTEE against functional defect in material or workmanship in a residential application. Waterstone does not, however, guarantee its products against defects due to improper installation, the failure to perform proper maintenance or uses for which the products were not designed. Products not manufactured by Waterstone but distributed by Waterstone carry only the original manufacturer's warranty. Waterstone has no liability for consequential or indirect damages and its only liability is to repair or replace, at its option, any of its products determined by Waterstone to have a manufacturing defect. Waterstone is not responsible for any labor charges, installation, or other consequential costs. Waterstone shall not pay any repair costs performed on its products by other than its authorized representatives unless Waterstone has given prior written approval to incur costs on its behalf.



WARNING - SINCE 2005, WATERSTONE HAS CONTINUED TO ADVISE ALL OF OUR CUSTOMERS AGAINST THE INSTALLATION OF ANY BRAND OF IN-LINE WATER CHILLER UNITS WITH OUR FAUCETS.

Compressor style chiller units have been proven to arbitrarily exceed the standard household in line pressure ratings causing the faucet inlet connection line to burst and create the potential for water damage claims in the field.

USE OF AN IN-LINE INSTALLATION OF A WATER CHILLER WITH A WATERSTONE FAUCET OF ANY KIND WILL VOID OUR WARRANTY.

Waterstone can not and will not be held liable for damages created by a use for which our products were not designed. Waterstone will only recommend the installation of a water chiller in the vented side (in place of a hot tank) with one of our Hot Only or Hot and Cold Filtration faucet models.

For any questions or concerns about your faucet's warranty, contact Waterstone - 1-888-304-0660.

FINISH WARRANTIES

For a warranty claim for finish, a valid dated bill of sale or receipt from purchase must accompany any warranty request. This warranty is for normal wear and tear of finish surface, the warranty will be void for unintended use damage, lack of cleaning or improper cleaning and maintenance techniques directly resulting in a damaged finish.

LIFETIME WARRANTY

Waterstone carries a lifetime warranty on the following finishes:

Chrome (CH)
Stainless Steel (SS)

7 YEAR WARRANTY

Waterstone carries a 7 year warranty for the original purchaser from the date of sale. Warranty applies to normal wear for the following finishes:

Antique Brass (AB)
Antique Copper (AC)
American Bronze (AMB)
Antique Pewter (AP)
Black Nickel (BLN)
Chocolate Bronze (CHB)
Classic Bronze (CLZ)
Distressed Antique Brass (DAB)
Distressed Antique Copper (DAC)
Distressed American Bronze (DAMB)
Distressed Antique Pewter (DAP)
Gloss Black (GB)
Matte Black (MB)
Polished Brass (PB)
Polished Copper (PC)
Polished Nickel (PN)
Satin Brass (SB)
Satin Chrome (SC)
Satin Nickel (SN)
Venetian Bronze (VB)

NO WARRANTY

Waterstone does not offer a warranty on living or gold finishes. The rate of deterioration will vary either from exposure to chemicals, perspiration, climate conditions, or other factors. Tarnishing or excessive wear of these finishes is therefore, not a defect, but a normal process, which is unavoidable. Under these circumstances, products will not be repaired or replaced under warranty for normal tarnishing or wear finishes.

Antique Bronze (ABZ)
Caribbean Bronze (CB)
Black-Oiled Rubbed Bronze (ORB)
Polished Gold (PG)
Satin Gold (SG)
Tuscan Brass (TB)
Unlacquered Polished Brass (UPB)
Weathered Brass (WB)
Weathered Copper (WC)

UNILATERAL MINIMUM RETAIL PRICE [UMRP]

This policy becomes effective on January 1st 2017, all distributors and dealers continuing to do business with WATERSTONE on and after that date will be bound to the terms and conditions of this policy.

Waterstone Faucets is dedicated to providing our distributors and dealers with the highest quality, most innovative products sold through superior sales and marketing support. With this company objective in mind, Waterstone Faucets is introducing its Unilateral Minimum Retail Price (UMRP) Policy in order to maintain proper positioning of our products in the marketplace, to define guidelines for the use of Waterstone patented, trademarked and copyrighted product and materials, and to solidify and preserve a consistent value for our distributors and dealers.

UNILATERAL POLICY GUIDELINES -

Each distributor and dealer remains free to determine for itself the resale prices at which it will sell and promote its products and each distributor or dealer is free to independently decide whether or not to follow the WATERSTONE UMRP policy. WATERSTONE does not ask for, nor will it accept, any assurance of compliance or agreement from a distributor or dealer regarding the UMRP policy. WATERSTONE is unilaterally implementing the Policy. WATERSTONE will determine whether or not distributors and dealers are in violation of the UMRP policy and will enforce the policy as it is warranted. All Decisions by WATERSTONE to take action for a violation of the UMRP Policy are final. There will be no negotiations.

The UMRP policy applies to discounted products, clearance items and closeouts. Waterstone has a very liberal return and repair policy. Products may be sent to us for repair to return them to their original saleable condition, therefore, the need for clearances and closeouts is unwarranted.

UMRP POLICY TERMS AND CONDITIONS -

WATERSTONE has established a Minimum Advertised Price (MAP) for all products. The Waterstone MAP is calculated at .75 times (25%) off current Waterstone Retail List Price in effect. This means that the advertised "Net Price" (The Waterstone Retail list price less all discounts, coupons, allowances, and free goods or services offered with Waterstone Products) must not be below the current WATERSTONE MAP.

WATERSTONE may engage in monitoring of advertised prices of Product sales in all channels, whether directly or via the use of third parties. Third parties retained by WATERSTONE may engage in monitoring of Product sales by distributors and dealers to verify that the terms of this Policy are being upheld. WATERSTONE reserves the right to change the MAP on 30 days written notice.

The UMRP policy applies to any and all advertisements, quotes, bids, estimates and invoices in all media including, but not limited to, inserts, newspapers, magazines, catalogs, public signage, billboards, and any other print media, television, radio, email, internet websites or other commerce, flyers, posters, coupons, brochures, and use of hypertext transfer protocol or internal links to a web based shopping cart and any other electronic media.

At no time may a distributor or dealer make any statements or other indication on any advertisements that a price below WATERSTONE'S MAP can be obtained by contacting the distributor or dealer, visiting the distributor or dealer showroom, clicking through to another price on a website, or any other means. A distributor or dealer may not use any WATERSTONE name(s), trademark(s), logo(s), patent(s) or products names(s), in a way that is not in accordance with this Policy or violates WATERSTONE'S MAP. This includes all product images, brand logos and any and all copyrighted materials.

VIOLATIONS -

In the event that a distributor or dealer violates this policy:

FIRST VIOLATION – WATERSTONE will notify the offending distributor or dealer in writing of the violation. The distributor or dealer will have ten (10) calendar days to correct the violation of the UMRP Policy and comply with WATERSTONE MAP.

If the distributor or dealer fails to correct the violation within the provided time, WATERSTONE will decrease the discounted price at which the distributor or dealer purchases WATERSTONE products by 10 percent for a period of ninety (90) calendar days. Additionally, WATERSTONE will remove the distributor or dealer from all links and listing on WATERSTONE'S website, and the distributor or dealer will be suspended from all sales programs offered to the distributor or dealer including but not limited to rebates, early pay incentives, freight programs, and sales incentives.

If at the end of the 90 day suspension period the distributor or dealer has complied with the policy and not otherwise violated the MAP, then the distributor or dealer will be reinstated to full status, and the suspended distributor or dealer programs will be re-started.

However, if the distributor or dealer continues to be in violation of the UMRP policy at the end of the ninety (90) day suspension period, it will be considered a second violation.

SECOND VIOLATION – At this time all pending orders will be immediately cancelled, and WATERSTONE will not accept any new orders. WATERSTONE will notify the distributor or dealer in writing and at its own discretion and without liability under any existing contracts or agreements, initiate the process to terminate the distributor or dealer authorization to sell WATERSTONE products.

DROP SHIP POLICY

WATERSTONE DROP SHIPMENT OUT OF REPRESENTATIVES REGION POLICY

1. Waterstone is committed to keeping our direct customers "selling field" as level and even as possible. Our customers invest in product displays, inventory, training of their sales staff, etc. Therefore, we wish to assist our customer's efforts to obtain excellent margins when selling our products.

2. Waterstone will accept all orders from our direct purchase customers in qualified credit status and ship those orders to the customer's immediate local trading area. Any customer may certainly re-ship our product(s) after they receive them at their location of business.

3. We will drop ship our product(s) for our direct purchase customer(s) within the geographic boundaries of their assigned Representatives Selling Region. We will not drop ship outside of these areas.

SALES AIDS



WHEN YOU THINK
WATERSTONE

— ★ —
Think MADE IN AMERICA
SINCE 1999
— —



- ★ **30 FINISHES PLUS SOLID STAINLESS STEEL.**
- ★ **MADE FROM SOLID BRASS or 316 MARINE GRADE SOLID STAINLESS STEEL.**
- ★ **LIFETIME FUNCTIONAL WARRANTY ON WATERSTONE MADE ITEMS.**
- ★ **LOW LEAD, CAL GREEN, ASME, NSF61, CSA & MASS CODE APPROVED.**
- ★ **KITCHEN, PREP, BAR & FILTRATION FAUCETS IN ALL STYLES & FINISHES.**
- ★ **COUNTER MOUNTED BRIDGE FAUCETS AVAILABLE WITH & W/OUT SIDE SPRAYS.**
- ★ **UNDER SINK PACKAGES - HOT TANKS, FILTRATION UNITS & LEAK DETECTORS.**
- ★ **DECORATIVE CABINET HARDWARE IN TRADITIONAL & CONTEMPORARY STYLES.**
- ★ **PATENTED GANTRY FAUCETS IN BOTH TRADITIONAL & CONTEMPORARY STYLES.**
- ★ **WALL & COUNTER MOUNT POTFILLERS IN TRADITIONAL & CONTEMPORARY STYLES.**
- ★ **POSITIVE LOCK PULLDOWN 'PLP' FAUCETS IN 3 STYLES WITH 3 SIZES IN EACH STYLE.**
- ★ **WATERSTONE MAKES MORE PRODUCTS THAN ANY KITCHEN FAUCET MANUFACTURER.**

QUALITY FEATURES OF WATERSTONE FAUCETS

- Our products are designed, engineered and **MADE IN THE USA**.
- All faucets feature solid brass or stainless steel construction.
- All faucets feature above the counter-top access for servicing.
- Kitchen, Prep, Gantry and 'PLP' faucets feature a single lever control with hot and cold ceramic disk valve cartridges.
- All Kitchen, Bridge and Prep faucets have a **built-in diverter valve** that allows for the addition of an optional side spray at any time.
- All Kitchen, Prep, Gantry and 'PLP' faucets feature a PTFE "Friction Lock" assist on the control handles which allows for adjustment of the handle tension.
- 1600 psi seals are used in the swivel joints on all articulated models and Potfillers.
- All single lever control handles adjust **22-1/2 degrees** (right or left) to allow for clearance from back splashes.
- All Contemporary Gantry, Kitchen, and Prep style faucets feature reversible and removable Hot and Cold indicator rings.
- All Traditional style faucets include a choice of 3 control handle buttons (Hot/Cold, Cold/Hot, and faucet Finish Match).
- Quick 'Snug and Lock' attachment hardware is included with all Kitchen, Bridge, Prep, Gantry, 'PLP' Faucets, and Decorative Air Gaps, providing ease of installation.
- All faucets are factory water tested.
- Reinforced braided connection hoses are included and factory installed on all Kitchen, Bridge, Prep, Bar, Gantry and 'PLP' Faucets.
- Neoperl aerators are used on all Kitchen, Bridge, Prep, Bar, 'PLP' Faucets and Potfillers.
- Wall Mounted Potfillers and Deck Mounted Potfillers feature ceramic disk valves, **built-in check valves** to prevent dripping and provide a **22"** long reach.
- All faucets are manufactured to be fully compliant with the California AB-1953 Low Lead statute.
- All faucets can be used with aggressive water (Reverse Osmosis) filtration systems.
- Up to a 1.75 gpm flow rate on Kitchen, Bridge, Prep and Bar Faucets, and 1.1 gpm on Filtration Faucets is standard.
- Decorative Air Switches feature above the counter top design and are **ADA** compliant.



***THE MOST INNOVATIVE FAUCET PRODUCTS
IN THE INDUSTRY***

★ ★ MADE IN AMERICA

SINCE ★ ★
1999 ★ ★



AVAILABLE IN ALL
CONTEMPORARY
STYLES

SOLID
STAINLESS
STEEL



THE ONLY MANUFACTURER THAT
"SUITES" The KITCHEN



WATERSTONE ACCESSORIES
MATCH IN BOTH STYLE AND
FINISH

USA BASED
CUSTOMER SERVICE



MONDAY - FRIDAY 7:30AM TO 5PM PST

ALL FAUCETS ARE MANUFACTURED TO BE FULLY COMPLIANT WITH THE

LOW LEAD
STATUE *CALGreen*

AND COMPLY WITH CAL GREEN STANDARDS

MANUFACTURED WITH



NOBODY *But* WATERSTONE

MOST POPULAR FINISHES FOR 2017

A SELLING GUIDE FOR THE HOT HUES!

1. POLISHED NICKEL - PN
2. SATIN NICKEL - SN
3. CHROME - CH
4. STAINLESS STEEL - SS
5. ANTIQUE PEWTER - AP
6. SATIN BRASS - SB 
7. UNLAQUERED POLISHED BRASS - UPB
8. BLACK NICKEL - BLN
9. AMERICAN BRONZE - AMB
10. MATTE BLACK - MB 
11. ANTIQUE BRASS - AB
12. DISTRESSED ANTIQUE PEWTER - DAP
13. OIL RUBBED BRONZE - ORB
14. VENETIAN BRONZE - VB
15. DIST. AMERICAN BRONZE - DAMB
16. CARIBBEAN BRONZE - CB

2 WEEK LEAD TIMES!

ON THESE TOP 5 FINISHES



 = TRENDING NOW

BEAUTIFUL NEW FINISH FOR 2018!

INTRODUCING CLASSIC BRONZE

Classic BRONZE



*A PERFECT CHOICE FOR
KITCHENS WITH WARMER
HUES AND EARTH TONES.*



In a response to Dealers, Architects and Kitchen Designers, Waterstone has created a new faucet finish that will add a rich warmth and earth tones to any kitchen. Waterstone is proud to announce the 30th addition to our finish collection – Classic Bronze. We have provided a new hue that will help recreate that early American style and will bring a timeless beauty to any traditional or contemporary kitchen. Classic Bronze is a perfect choice for someone who needs a finish between the shine of a Satin Brass and the darker patina of a Antique Bronze.

316 MARINE GRADE STAINLESS STEEL

WE'VE UPGRADED!

New for 2018, when you order Stainless Steel from Waterstone you get **316 MARINE GRADE STAINLESS STEEL**.



FEATURES

- Maximum resistance to corrosion, pitting and staining.
- Perfect for outdoor kitchens.
- Durable and low maintenance.
- Maintains luster.
- Higher yield strength.
- Lifetime warranty.
- Available on all contemporary faucet and accessories.



MORE RESISTANCE TO CORROSION FROM SITTING WATER OR SOAP.

The high quality you've come to expect from Waterstone has just gotten better. We are introducing **316 MARINE GRADE** Stainless Steel. This exceptional stainless steel is stronger for a lifetime of durability and has maximum resistance to rust, pitting, corrosion and staining. It is the same top quality stainless steel used on ships and surgical equipment. Waterstone will begin creating contemporary faucets and accessories with this new durable 316 material beginning March 16th, 2018. Did we really need to offer better stainless steel? No, but we did it anyway! We're Waterstone and we are always looking for better ways to create the best kitchen faucets in the world.



THE HUNLEY CONTEMPORARY
KITCHEN SUITE MADE WITH 316

THE WHEEL PULLDOWN FAUCET



**YOU CAN RE-INVENT
THE WHEEL**

5100

MEETS THE FOLLOWING

- ASME A112.18.1
- CSA B125.1
- NSF 61, 372
- AB1953 Low Lead
- CAL Green

MAKE IT A SUITE!

Add accessories that match your faucet in both style and finish.



4010

4020/4030

4055

4060

FEATURES

- Designed, engineered and made in the USA.
- Solid brass construction.
- Available in 30 elegant finishes.
- “Easy Pull” continuous force spring controls pull-down feel.
- Pulley braking system prevents handle snap back.
- Spray head extends 20” from spout.
- Ergonomic lever handle for spray function.
- 1.75 gpm maximum flow rate with stream selected.
- Braided connection hoses.
- Compatible with Reverse Osmosis filtration systems.
- 360 degree swivel spout.
- Lifetime functional warranty.
- Single lever control hot/cold ceramic disk valve cartridge.
- Above the countertop access for servicing.
- Handle can be adjusted up to 22.5 degrees (right or left) for clearance from backsplashes.
- 3 handle buttons included. Hot/cold, cold/hot and matching finish.



TRADITIONAL PLP PULLDOWN FAUCETS

Model # 5200, 5500, 5600

**NOW AVAILABLE!
PREP SIZE
PULLDOWNS**



5200



5500



5600-4

Single Package, 2, 3 and 4 Piece
Mini-Suites Available

Unique '**PLP**' positive lock holds spray head in place.

1

Squeeze lever handle to switch from aerated stream to spray **during** faucet operation.

2

RUB CLEAN spray face for easy cleaning.

3

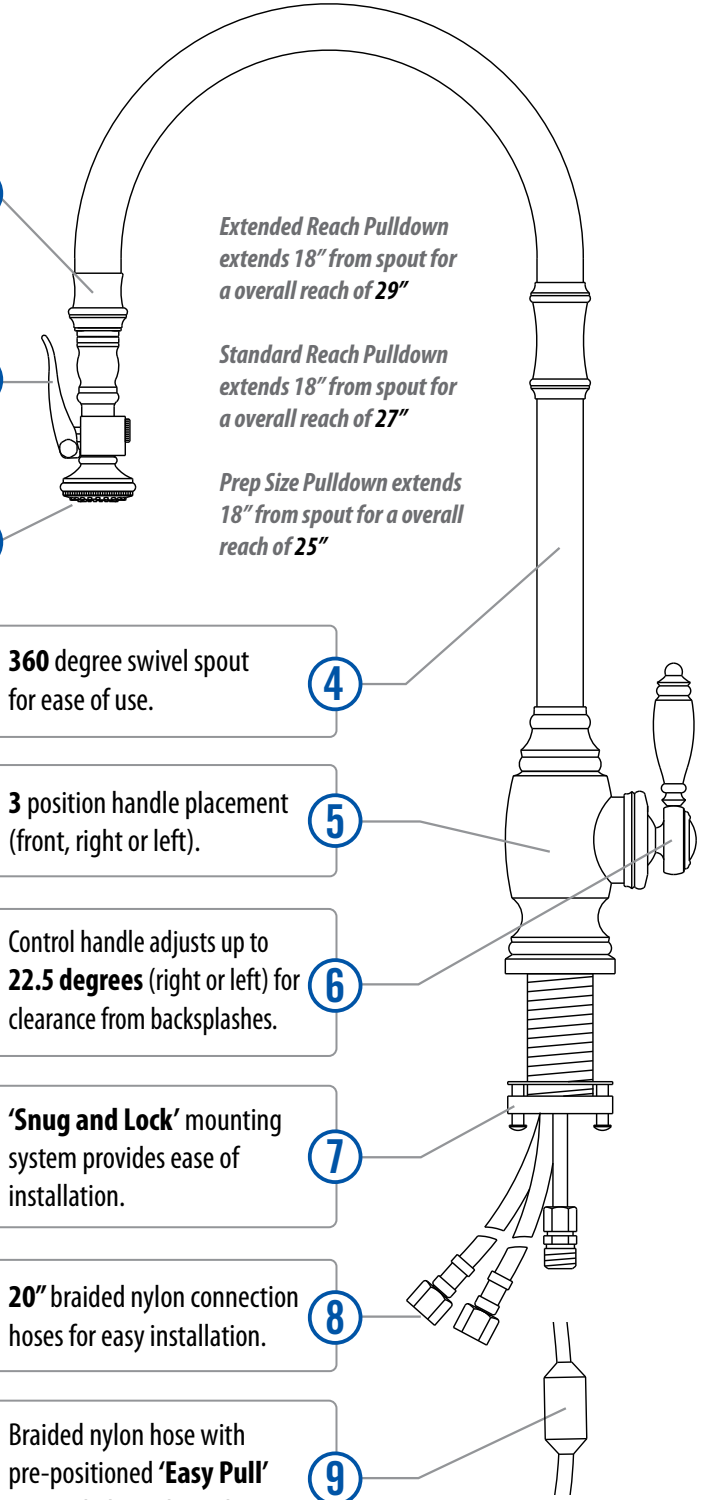

Extended Reach Pulldown extends 18" from spout for a overall reach of 29"

Standard Reach Pulldown extends 18" from spout for a overall reach of 27"

Prep Size Pulldown extends 18" from spout for a overall reach of 25"

360 degree swivel spout for ease of use.

4

3 position handle placement (front, right or left).

5

Control handle adjusts up to **22.5 degrees** (right or left) for clearance from backsplashes.

6

'**Snug and Lock**' mounting system provides ease of installation.

7

20" braided nylon connection hoses for easy installation.

8

Braided nylon hose with pre-positioned '**Easy Pull**' counterbalanced weight.

9

CONTEMPORARY & TRANSITIONAL PLP PULLDOWN FAUCETS

Model # 5300, 5400, 5700, 5800, 5900, 5930

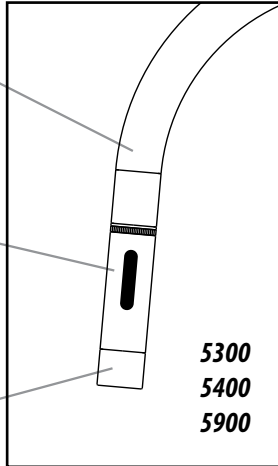

1 Unique 'PLP' positive lock holds spray head in place.

2 Squeeze toggle handle to switch from aerated stream to spray **during** faucet operation.

3 Aerator is removable for **easy** cleaning.

5300
5400
5900

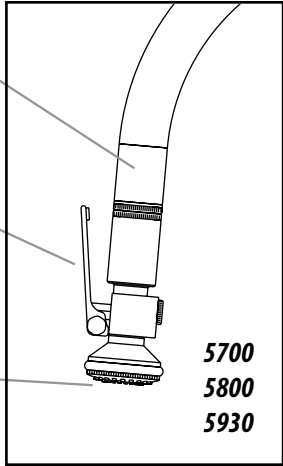

1 Unique 'PLP' positive lock holds spray head in place.

2 Squeeze lever handle to select spray **during** faucet operation.

3 **RUB CLEAN** spray face for easy cleaning.

5700
5800
5930

- *Extended Reach Pulldown extends 18" from spout for a overall reach of 29"*
- *Standard Reach Pulldown extends 18" from spout for a overall reach of 27"*
- *Prep Size Pulldown extends 18" from spout for a overall reach of 25"*

NOW AVAILABLE! PREP SIZE PULLDOWNS



Single Package, 2, 3 and 4 Piece Mini-Suites Available

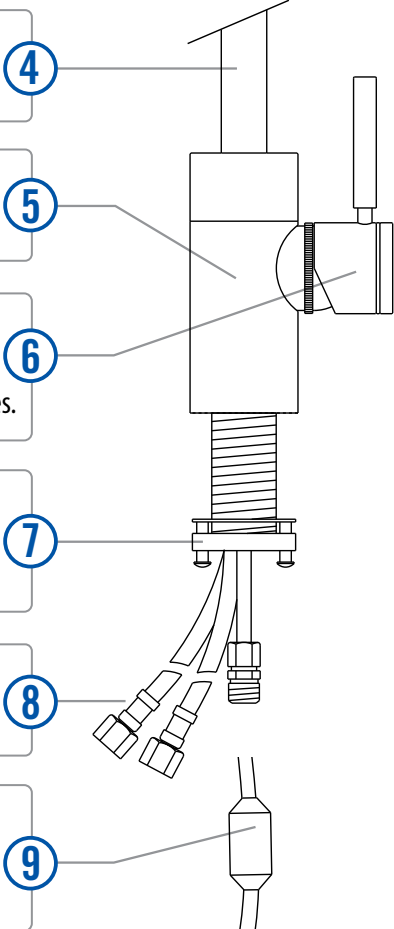

4 **360** degree swivel spout for ease of use.

5 **3** position handle placement (front, right or left).

6 Control handle adjusts up to **22.5 degrees** (right or left) for clearance from backsplashes.

7 '**Snug and Lock**' mounting system provides ease of installation.

8 **20"** braided nylon connection hoses for easy installation.

9 Braided nylon hose with Pre-positioned '**Easy Pull**' counterbalanced weight.

TRADITIONAL BRIDGE FAUCETS

FEATURES

- Two-holed Bridge Faucet design.
- Hook, Articulated, or C-spout styles.
- Optional side spray available.
- Dual lever or cross handle options.
- Solid brass construction.
- 360 degree swivel spout.
- Available in 30 elegant finishes.
- Lifetime functional warranty.



ANNAPOLIS - 6200
ANNAPOLIS - 6250*



HAMPTON - 6300
HAMPTON - 6350*



***CROSS HANDLES**
AVAILABLE



2 STYLES OF HANDLE
CAPS INCLUDED WITH
EACH FAUCET



TOWSON - 6100-12
TOWSON - 6100-18

TOWSON - 6150-12*
TOWSON - 6150-18*

MAKE IT A SUITE!

Add accessories that match your faucet in both style and finish.



4010

4020/4030

4055

4060

4025

CONTEMPORARY BRIDGE FAUCETS



FULTON - 7825



PARCHE 7800



REMOVABLE HOT COLD INDICATOR RINGS

FEATURES

- Two-hole Bridge Faucet design.
- 2-Bend, Articulated, or C-spout styles.
- Optional side spray available.
- **Solid** brass or stainless steel construction.
- 360 degree swivel spout.
- Available in 30 finishes or stainless steel.
- Lifetime functional warranty.

MAKE IT A SUITE!

Add accessories that match your faucet in both style and finish.



3010



3020/3030



4065



3025



HUNLEY - 7600-12

HUNLEY - 7600-18

THE ULTIMATE UNDER SINK PACKAGE

MODEL # 1000



ULTIMATE UNDER SINK SYSTEM INCLUDES:

- #5000 Hot Tank
 - #4500 PRV (pressure regulator valve)
 - #30101 Multi-Stage Filtration Unit
 - #AS-414 Safety Valve-Leak Detection
- Connection fittings included as shown.

Provides all three Waterstone Under Sink Products in a single package. Get filtered, great tasting water with the security of leak detection. The Waterstone Multi-Stage Filtration System when used with a Waterstone Filtration Faucet, removes sediment, chlorine, bad taste and odor from municipal drinking water. The Hot Tank and PRV (pressure regulator valve) dispenses steaming hot water instantly. Perfect for making hot coffee, tea or cooking. Waterstone's Safety Valve Leak Detection units automatically shuts off the water source when it detects moisture and minimizes water damage. The Hot Tank carries a **2 Year Warranty**.

THE ULTIMATE UNDER SINK PACKAGE

In One Complete Package

MODEL# 1000 Includes:

- 5000 Hot Tank
- 4500 Pressure Regulator Valve
- 30101 Multi-Stage Filtration Unit
- AS-414 Safety Valve-Leak Detector
- Connection fittings included as shown.

ADD A WATERSTONE FILTRATION FAUCET

A Waterstone Hot and Cold, or Hot Only Filtration Faucet completes the package. (faucet not included)

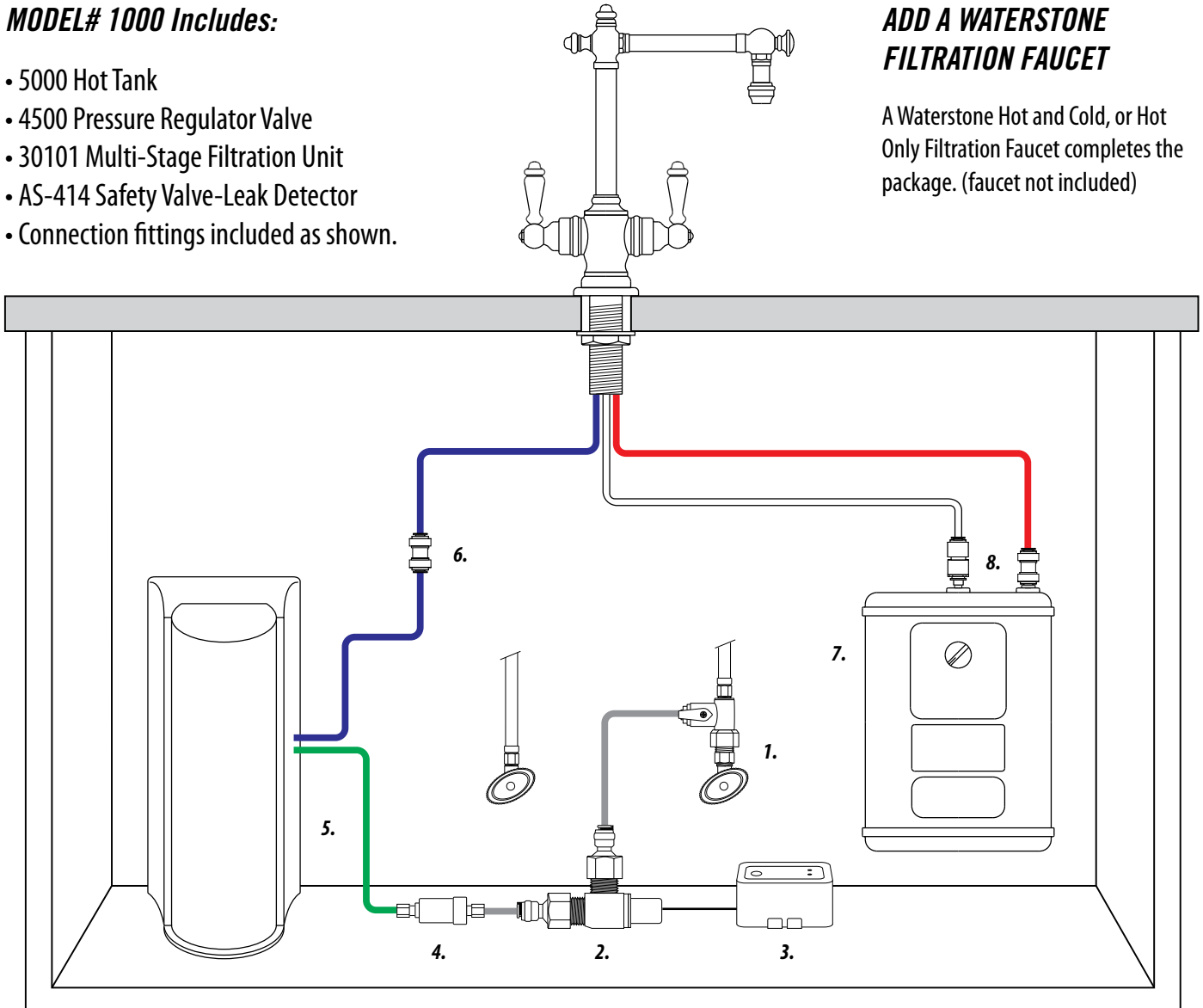

1. COLD WATER SOURCE
2. #AS-414 SAFETY VALVE
3. MOISTURE SENSOR

4. #4500 PRV VALVE
5. #30101 FILTRATION UNIT
6. CONNECTION FITTING

7. #5000 HOT TANK
8. CONNECTION FITTINGS

THE INSTA-HOT UNDER SINK PACKAGE

Instant Hot Water and Leak Protection in One Package

MODEL # 2000

The Insta-Hot package gives you instant hot water and the security of flood prevention. Includes a Waterstone Hot Tank, PRV (pressure regulator valve) and a Safety Valve Leak Detector unit in a single package. Hot Tank is designed with an integrated vent that works with any Waterstone Hot and Cold, or Hot Only Filtration faucets. The 1/2 gallon stainless steel tank dispenses steaming hot water instantly and is perfect for making hot coffee, tea, cooking or sink cleanup. An insulated, solder less, heating tank, the Waterstone Hot Tank has an adjustable temperature control that ranges from 140F to 190F (60C to 88C). Kitchen flooding often happens without warning and can cause substantial flooding and property damage if nobody is around to stop it. Waterstone's Safety Valve Leak Detection Units are ideal for minimizing water damage when these disasters occur. Our Leak Detector automatically shuts off the water source when it detects moisture. Once the valve shuts off, the unit sounds off with an audible alarm, like a smoke detector, to let you know of a problem. The Hot Tank carries a **2 Year Warranty**.



5000

PRV



AS-414

INSTA-HOT UNDER SINK SYSTEM INCLUDES:

- #5000 Hot Tank
 - #4500 PRV (pressure regulator valve)
 - #AS-414 Safety Valve-Leak Detection
- Connection fittings included as shown.

THE INSTA-HOT UNDER SINK PACKAGE

Instant Hot Water and Leak Protection in One Package

MODEL# 2000 Includes:

- 5000 Hot Tank
- 4500 Pressure Regulator Valve
- AS-414 Safety Valve-Leak Detector
- Connection fittings included as shown.

**ADD A WATERSTONE
FILTRATION FAUCET**

A Waterstone Hot and Cold, or Hot Only Filtration Faucet completes the package. (faucet not included)

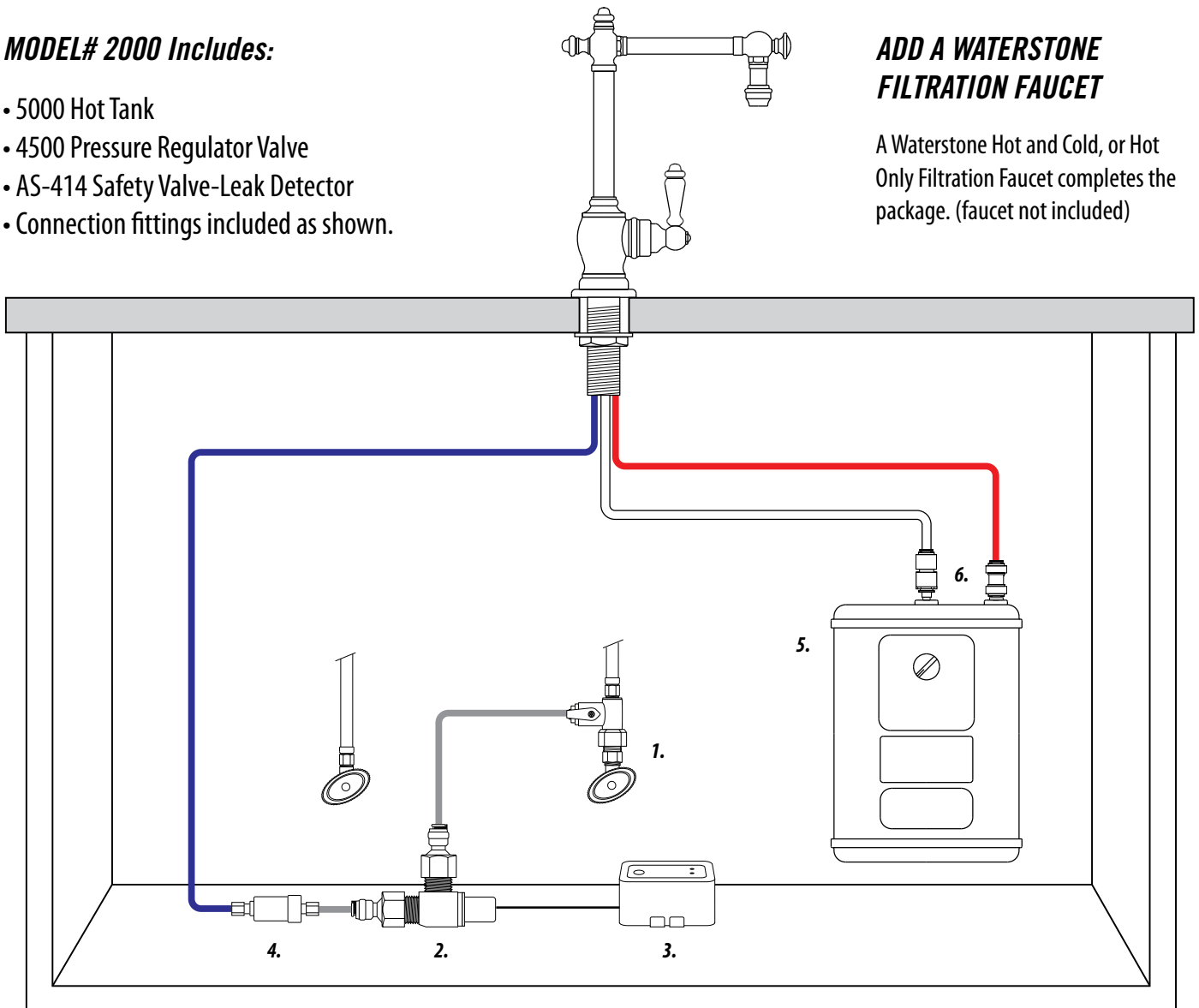

1. COLD WATER SOURCE
2. #AS-414 SAFETY VALVE

3. MOISTURE SENSOR
4. #4500 PRV VALVE

5. #5000 HOT TANK
6. CONNECTION FITTINGS

THE FILTRATION UNDER SINK PACKAGE

Water Filtration and Leak Protection in One Package

MODEL# 3000

Provides a **1000** gallon capacity point of use Multi-Stage Filtration System and a Safety Valve Leak Detector unit in a single package.



30101



AS-414

THE FILTRATION UNDER SINK PACKAGE

Water Filtration and Leak Protection in One Package

MODEL# 3000 Includes:

- 30101 Multi-Stage Filtration Unit
- AS-414 Safety Valve-Leak Detector
- Connection fittings included as shown.

ADD A WATERSTONE FILTRATION FAUCET

A Waterstone Cold Only Filtration
Faucet completes the package.
(faucet not included)

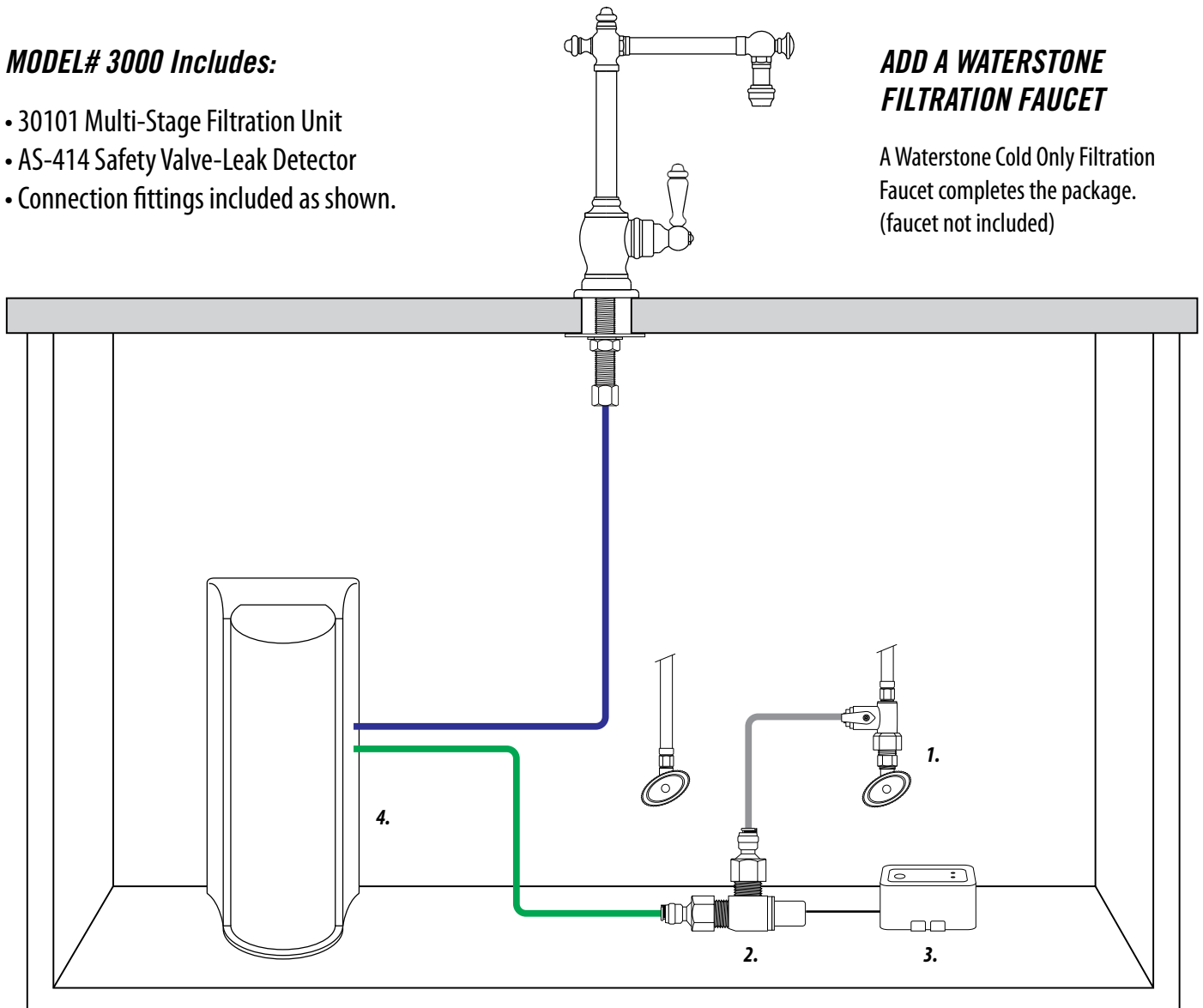

1. COLD WATER SOURCE
2. #AS-414 SAFETY VALVE

3. MOISTURE SENSOR
4. #30101 FILTRATION SYSTEM

HOT TANK

Instant Hot Water Heating Unit

MODEL# 5000

Why wait for steaming, hot water? Get instant hot water up to 60 cups an hour! Perfect for making hot coffee, tea, cooking or sink cleanup. Designed with a non-pressurized bladder system that works with any Waterstone Hot and Cold, or Hot Only Filtration faucets, the 5/8 gallon stainless steel tank dispenses steaming hot water instantly. Adjustable temperature 140F to 190F (60C to 88C). Includes a pressure regulator valve (PRV). Compatible with RO filtration systems. The Hot Tank carries a **2 Year Warranty**.



5000

HOT TANK

Instant Hot Water Heating Unit

MODEL# 5000 Includes:

- 5000 Hot Tank
- 4500 Pressure Regulator Valve
- Connection fittings included as shown.

ADD A WATERSTONE FILTRATION FAUCET

A Hot and Cold, or Hot Only Filtration Faucet completes the package. (faucet not included)

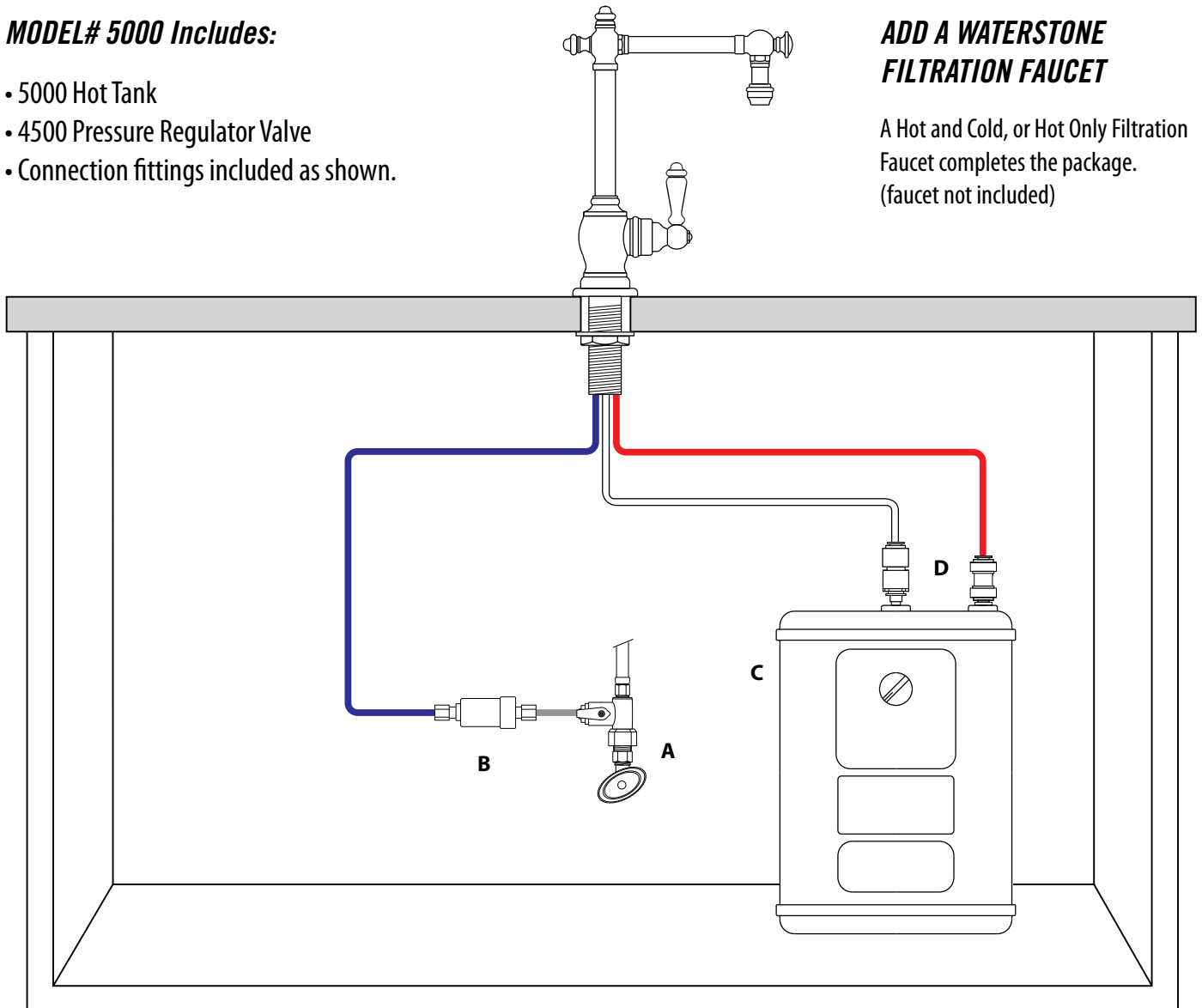

(A) WATER SOURCE
(B) #4500 PRV VALVE

(C) #5000 HOT TANK
(D) CONNECTION FITTINGS

FAUCET GLOSSARY

AERATOR

A device normally placed at the end of the spout on a faucet and designed to introduce a mixture of air to the water stream. Its intended function is to produce a nearly splash less straight or "clean" stream.

BAR FAUCET

A smaller overall size faucet intended to be used with smaller bar or prep sinks. Waterstone Bar Faucets do not have the ability to be used with a side spray.

CERAMIC DISC CARTRIDGE

A high quality valve that typically uses two ported ceramic discs to open, close, and/or mix the flow of water in a faucet body. These valves are characterized by their long and reliable service life.

CHECK VALVE

This is a small device that will allow water to flow in one direction, but not in the opposite direction.

CLEAR COATING

A clear, protective coating that is sprayed on the outside of a fixture's finish. It is used to seal and protect both faucet and finish.

CONNECTION HOSE

The hose that connects the faucet to the hot or cold water sources.

DISTRESSED FINISH

Refers to an accelerated aging process. Waterstone creates the outward appearance of a product that has survived years of aging and use. The aging process is done by mechanically marring, nicking and scratching the external surfaces. All internal functional areas remain new, ready for years of continual service. All of our distressed finishes are sealed with an outside clear coat to protect the look of the finish.

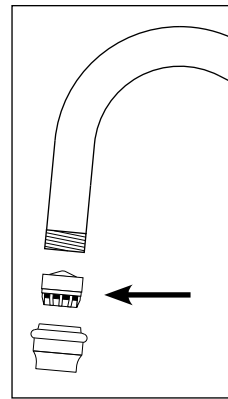

AERATOR



BAR FAUCET

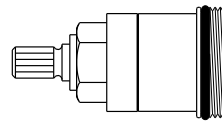

CERAMIC DISC CARTRIDGE



CLEAR COATING

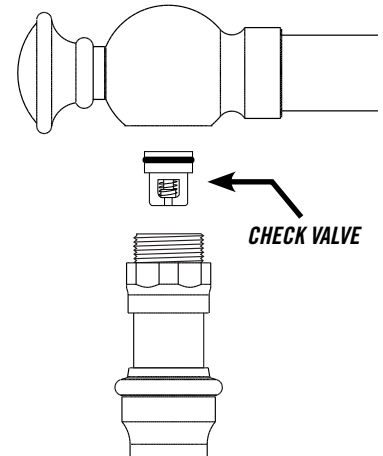

CHECK VALVE

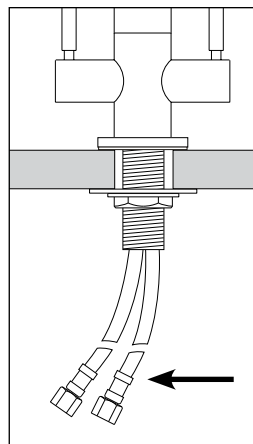

CONNECTION HOSES



DISTRESSED FINISH

FAUCET GLOSSARY

FILTRATION FAUCET

A drinking water faucet specifically designed to be used with water filtration systems. Typically a smaller faucet that is intended for low pressure water delivery.

FILTRATION UNDER SINK SYSTEM

Model #3000 includes a **1000** gallon capacity Filtration System and a Safety Valve-Leak Detector unit in a single package.

GANTRY® FAUCET

“Gantry” is a trademarked name for the Waterstone Faucets pre-rinse faucets. This faucet’s trademarked name was derived from the working Gantry crane’s range of motion and distinctive look.

HOT TANK

A small water heating tank designed to be used only with a vented filtration faucet and able to deliver hot water temperatures within a limited capacity. The Hot Tank carries a **2 Year Warranty**.

INSTA-HOT UNDER SINK SYSTEM

Model #2000 includes a Hot Tank and a Safety Valve-Leak Detector unit in a single package.

LIVING FINISH

A natural finish that will slowly change over time as it is exposed to oxidation and usage. Finish is not protected with any type of external or clear coating. Not considered a durable finish and is easily scratched or marred.

MULTI-STAGE FILTRATION SYSTEM

The 30101 filtration system has three separate filter sections all encapsulated in one easily replaceable sealed cartridge. Each step or “stage” of the filtration process is designed to remove a different level of water contaminate. The first **two** “stages” are considered pre-filters and the **third** “stage” is a Granulated Activated Carbon (GAC) filter designed to be the final trap for most of what is experienced in **municipal water systems**.



FILTRATION FAUCET



FILTRATION UNDER SINK SYSTEM



GANTRY FAUCET



HOT TANK



INSTA-HOT SYSTEM



MULTI-STAGE FILTRATION SYSTEM



LIVING FINISH

FAUCET GLOSSARY

PATINA

The external layer of oxidation that naturally occurs on the surface of the base metal. Metals react differently due to time frames and chemicals designed to accelerate this natural process which creates a variety of colors and hues that result in a living finish.



PATINA

POTFILLER

A faucet that is specifically designed to be mounted above (wall-mounted) or beside (deck-mounted) the kitchen stove top in order to deliver water directly to a cook pot or pan on the cooking surface. This faucet is usually a single handle cold water only fixture.

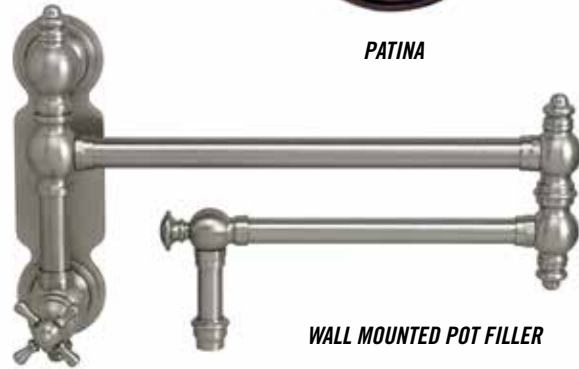

WALL MOUNTED POT FILLER

POWDER COATING

This is a type of decorative finish that is electro-statically painted on to the surface of the parts and subsequently baked on and "cured" in a commercial oven.



POWDER COATING

PREP FAUCET

A full size faucet that has a shorter reach spout to accommodate smaller prep and bar sinks. All Waterstone Prep Faucets have a built-in diverter which allows the addition of a Side Spray at any time.



PREP FAUCET

PRE-RINSE FAUCET

This faucet is borne from commercial kitchen use. It has found its way into residential culinary kitchens. In addition to the normal faucet spout, a pre-rinse faucet incorporates an attached hanging spray that is used for pre-rinsing cookware, dish ware, and utensils in the cleaning process. The Waterstone Gantry is a pre-rinse faucet.



PRE-RINSE PULL DOWN FAUCET

FAUCET GLOSSARY

SAFETY VALVE-LEAK DETECTOR

This automatic on/off device is designed with a sensor that can detect the presence of water in the base of the kitchen sink or vanity cabinet floor. When connected to a Waterstone Insta-Hot or Filtration Faucet when the unit detects moisture, the valve is automatically closed shutting down the flow of water to the faucet to prevent any further leaking or possible damage. Additionally, the unit sounds an audible alarm (like a smoke alarm) to further advise of a water leakage issue.



AS-414

ULTIMATE UNDER SINK SYSTEM

Model #1000 includes all three Waterstone Under Sink Products in a single package. The system includes a Hot Tank, 1000 gallon capacity Filtration System and a Safety Valve-Leak Detector unit. The Hot Tank carries a **2 Year Warranty**.



ULTIMATE SYSTEM

VENTED FAUCET

Sometimes called a “three line” faucet, this type of faucet is designed to work with in-line devices like Waterstone Faucet Hot Tanks that cannot handle full in-line pressure. The on and off valve is placed in front of the device and the water is routed through the device in the vented “loop” and returned back up through the end of the spout. This assures the in-line device is always open to ambient or atmospheric pressure (i.e. “vented”).

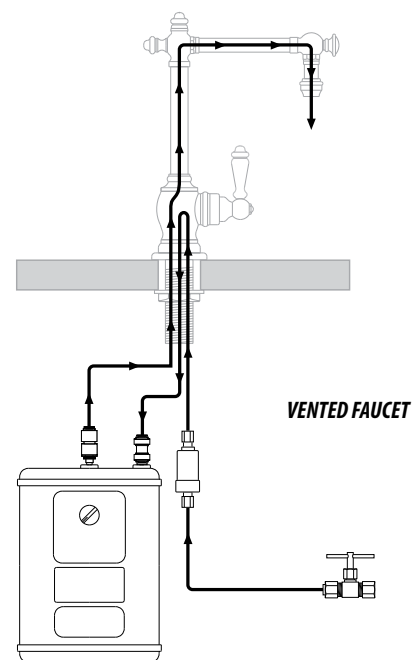

PRODUCTS



PULLDOWN FAUCETS

CONTEMPORARY STYLES

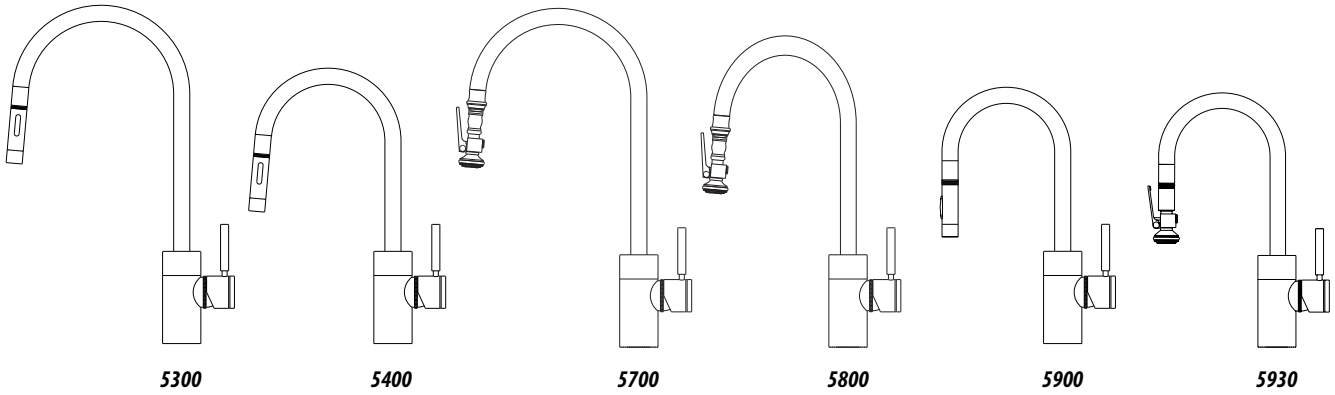

TRADITIONAL STYLES

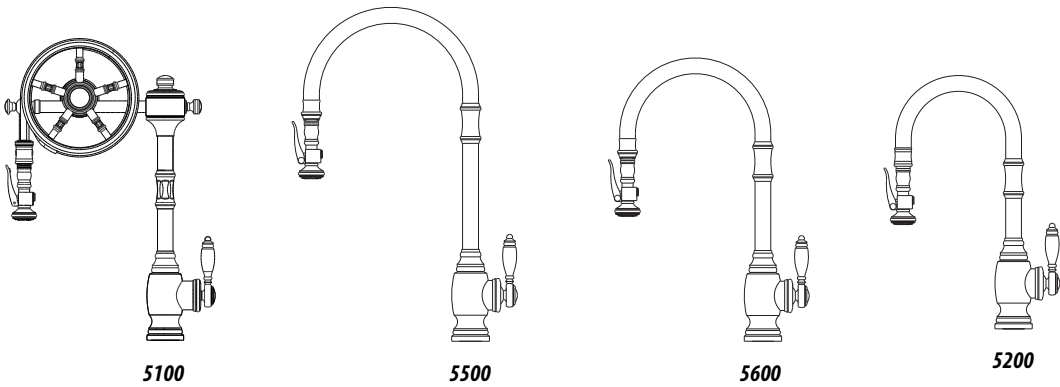

GANTRY PULLDOWN FAUCETS

CONTEMPORARY STYLES

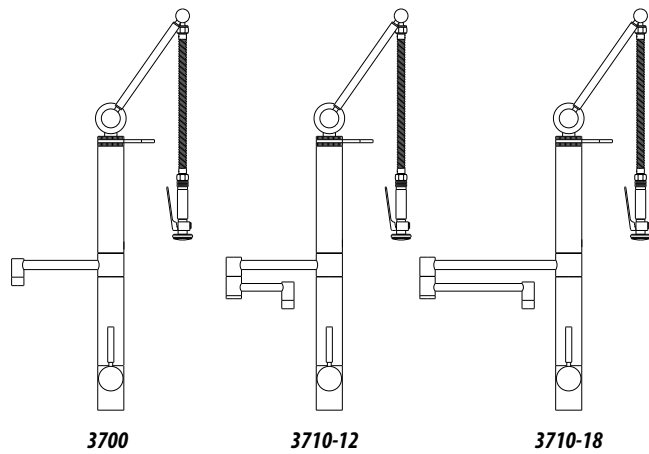

TRADITIONAL STYLES

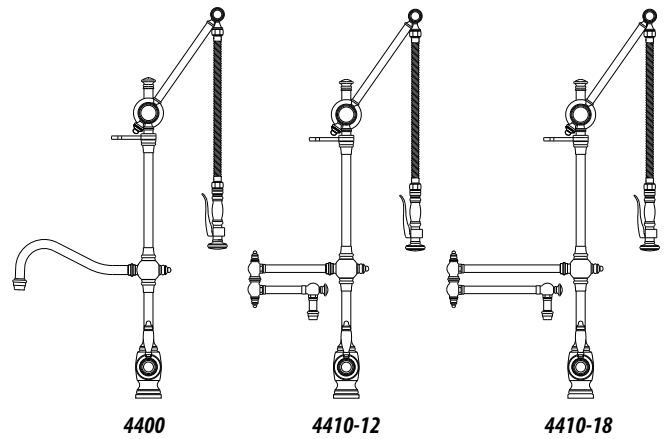

BRIDGE FAUCETS

TRADITIONAL STYLES

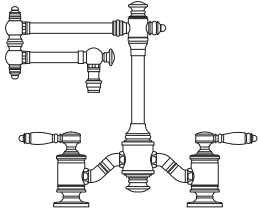

6100-12

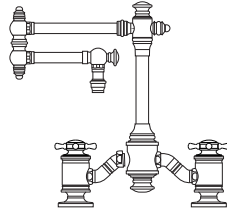

6150-12

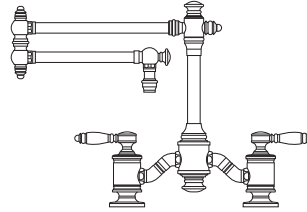

6100-18

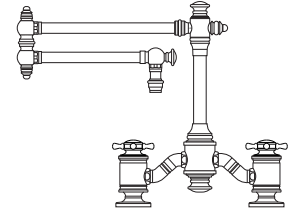

6150-18

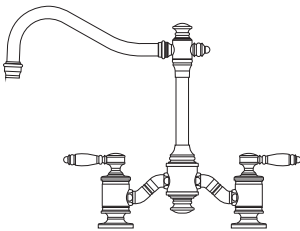

6200

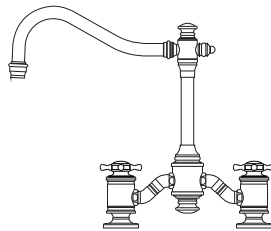

6250

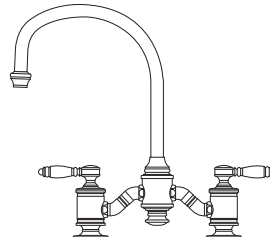

6300

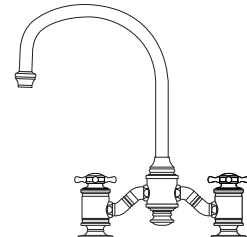

6350

CONTEMPORARY STYLES

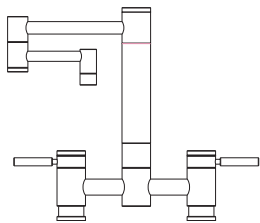

7600-12

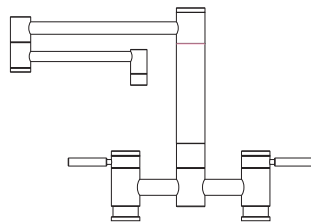

7600-18

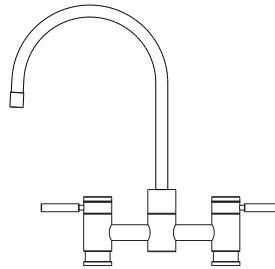

7800

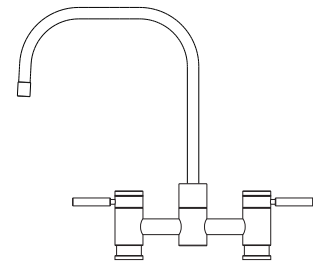

7825

POTFILLERS

WALL MOUNTED POTFILLERS

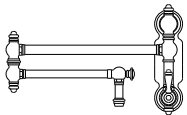

3100

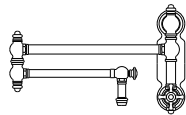

3150

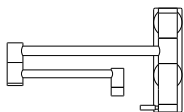

3200

COUNTER MOUNTED POTFILLERS

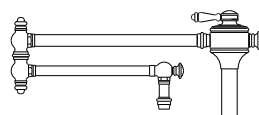

3300

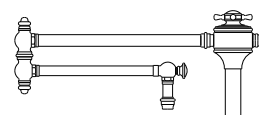

3350

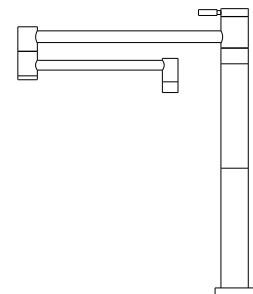

3400

KITCHEN FAUCETS

CONTEMPORARY STYLES

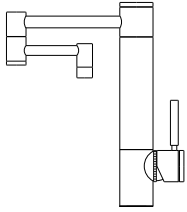

3600-12

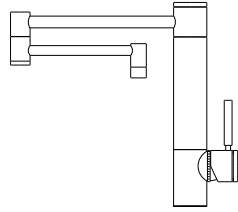

3600-18

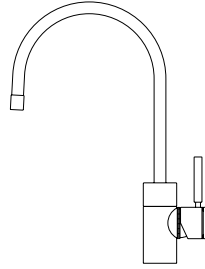

3800

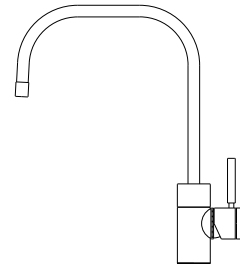

3825

TRADITIONAL STYLES

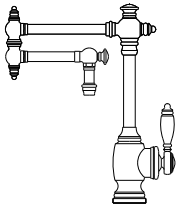

4100-12

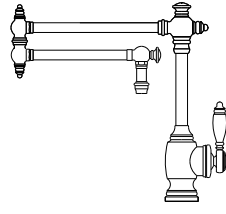

4100-18

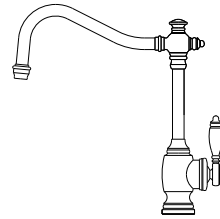

4200

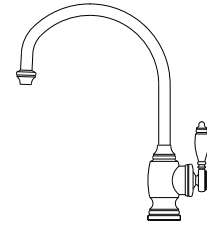

4300

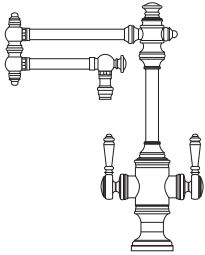

8010-12

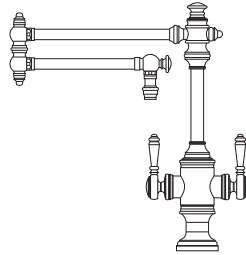

8010-18

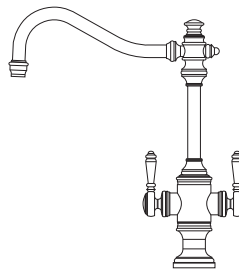

8020

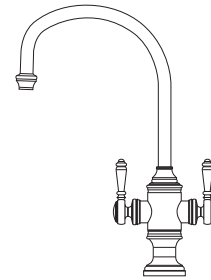

8030



PREP FAUCETS

CONTEMPORARY STYLES

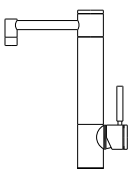

3500

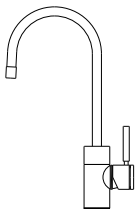

3900

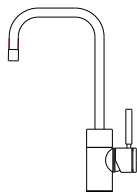

3925

TRADITIONAL STYLES

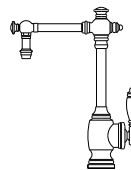

4700

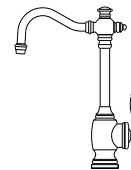

4800

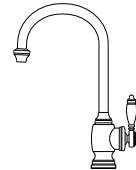

4900

BAR FAUCETS

TRADITIONAL STYLES

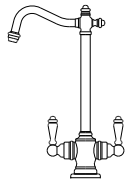

1300

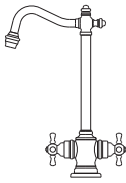

1350

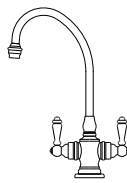

1500

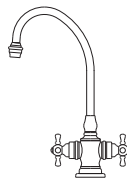

1550

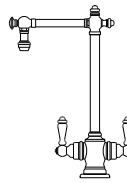

1800

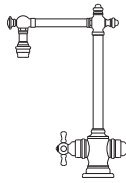

1850

CONTEMPORARY STYLES

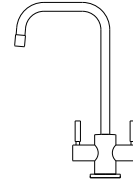

1625

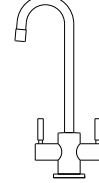

1600

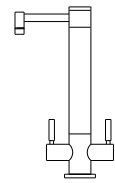

2500



FILTRATION FAUCETS

TRADITIONAL STYLES

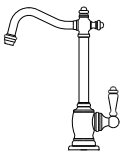

1100-C

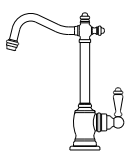

1100-H

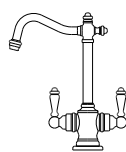

1100-HC

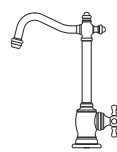

1150-C

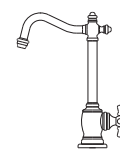

1150-H

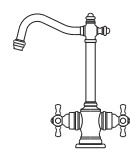

1150-HC

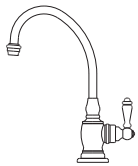

1200-C

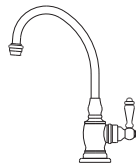

1200-H

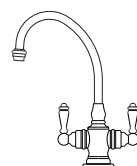

1200-HC

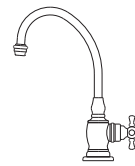

1250-C



1250-H

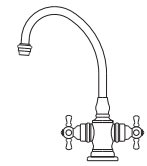

1250-HC

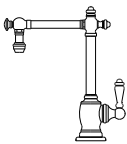

1700-C

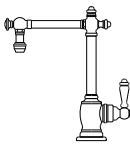

1700-H

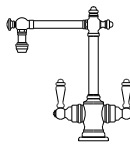

1700-HC

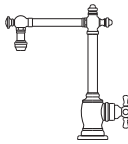

1750-C

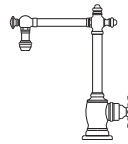

1750-H

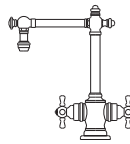

1750-HC

CONTEMPORARY STYLES

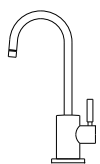

1400-C

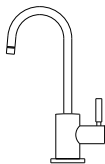

1400-H

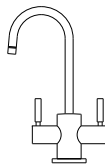

1400-HC

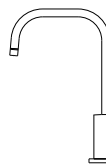

1425-C

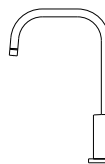

1425-H

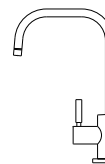

1425-HC

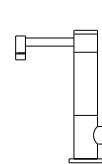

1900-C

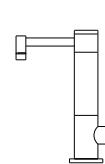

1900-H

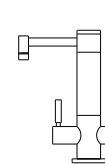

1900-HC

CONTEMPORARY ACCESSORIES



3010

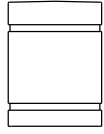

3020



3030

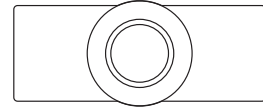

3783

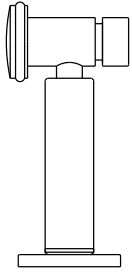

3025

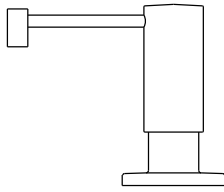

4065

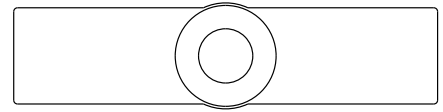

3784

TRADITIONAL ACCESSORIES



4010



4020



4030

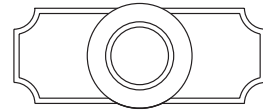

4783

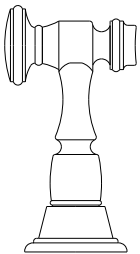

4025

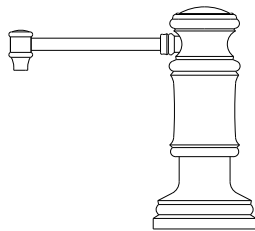

4055

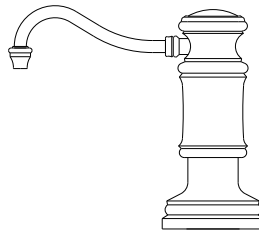

4060

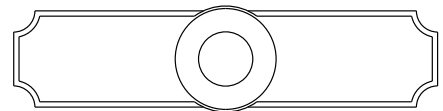

4784

DECORATIVE HOLE COVERS

CONTEMPORARY STYLE

TRADITIONAL STYLES

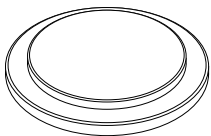

3080

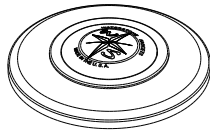

4070

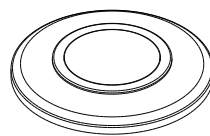

4080

UNDER SINK PRODUCTS

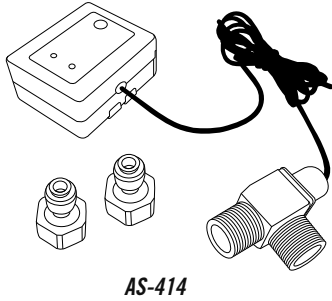

AS-414

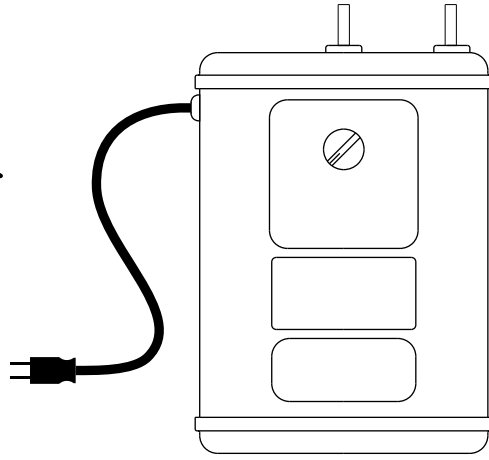

5000

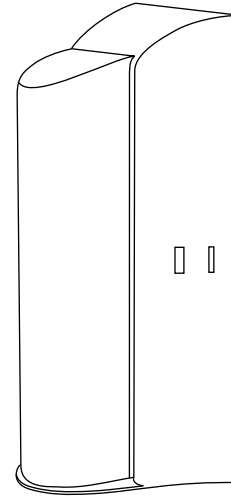

30101

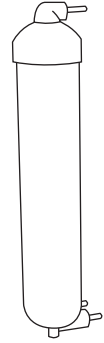

30102
30102-2



UNDER SINK PACKAGES

**ULTIMATE SYSTEM
1000**

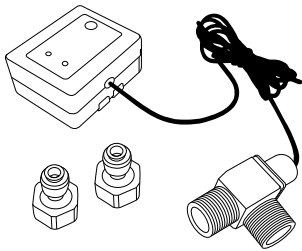

AS-414

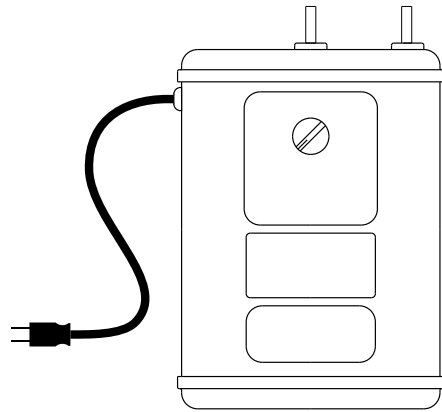

5000

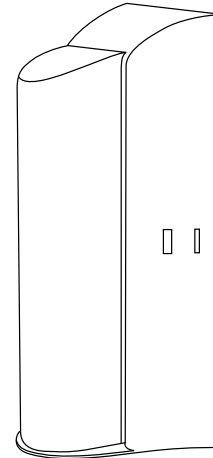

30101

**INSTA-HOT SYSTEM
2000**

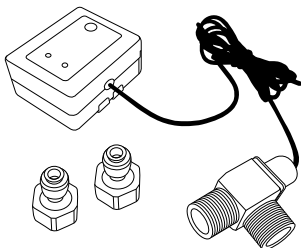

AS-414

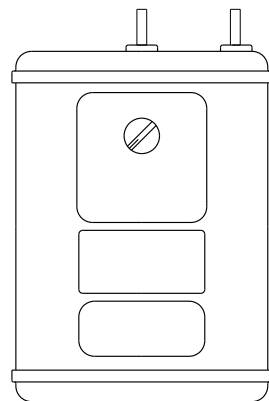

5000

**FILTRATION SYSTEM
3000**

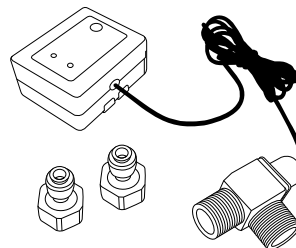

AS-414

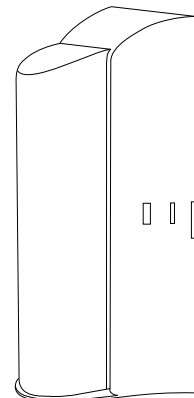

30101

TRADITIONAL CABINET KNOBS

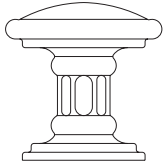

HTK-001

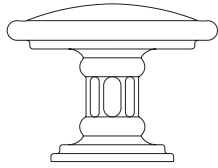

HTK-002

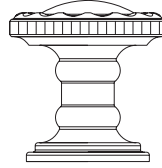

HTK-003

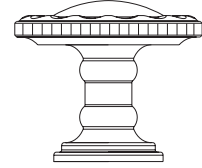

HTK-004

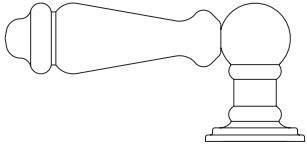

HTK-005

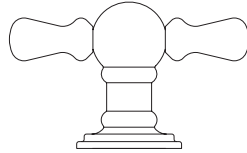

HTK-006

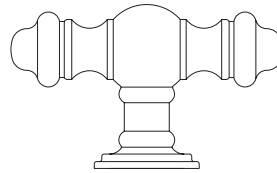

HTK-007

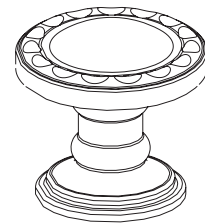

HTK-003 or HTK-004
Enlarged for Detail



CONTEMPORARY CABINET KNOBS

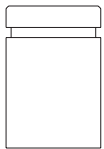

HCK-100

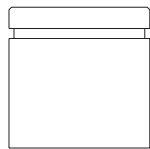

HCK-101

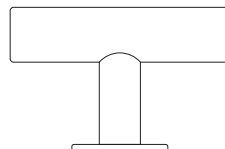

HCK-103

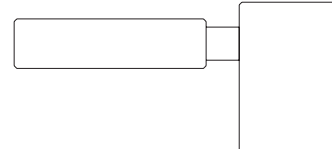

HCK-102

CABINET PULLS

TRADITIONAL STYLES

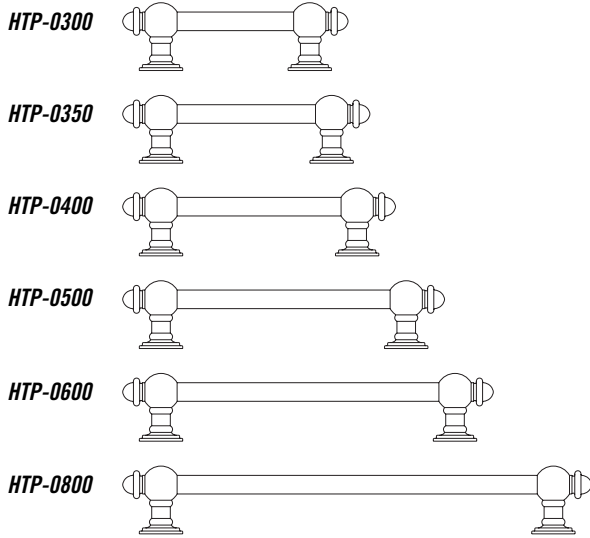

CONTEMPORARY STYLES

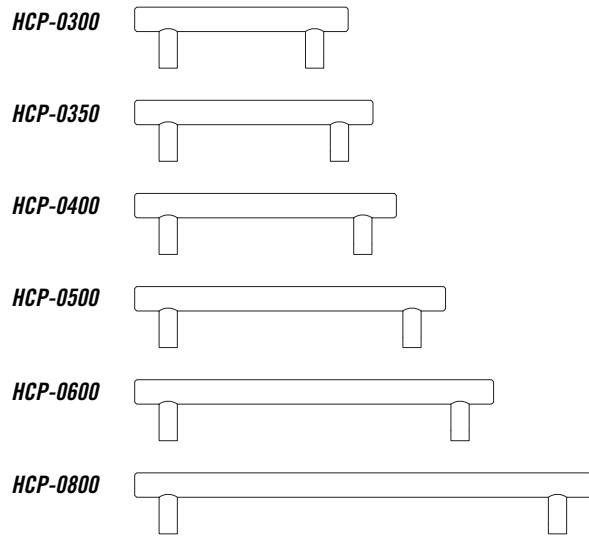

HEAVY DRAWER PULLS

TRADITIONAL STYLE



CONTEMPORARY STYLE

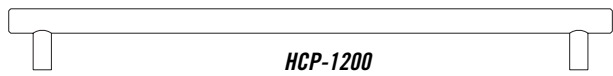

APPLIANCE PULLS

TRADITIONAL STYLES

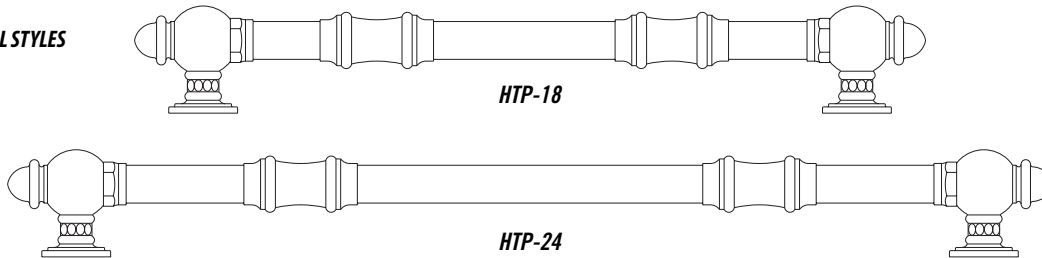

CONTEMPORARY STYLES

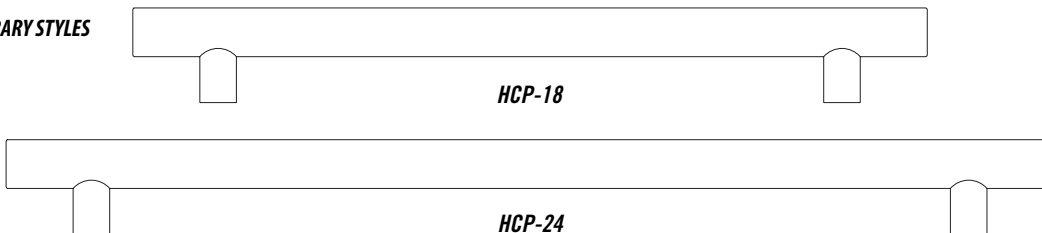

TRADITIONAL PLP PULLDOWN FAUCETS AND MINI-SUITES



- PLP** - Traditional Extended Reach Pulldown (5500)
- PLP** - Traditional Extended Reach Pulldown (5600)
- PLP** - Traditional Prep Size Pulldown (5200)

PLP PULLDOWN MINI-SUITES

All PLP Faucets can be "Suited." Add matching accessories. Available in **two**, **three** and **four** piece Suites.

CONTEMPORARY PLP PULLDOWN FAUCETS AND MINI-SUITES



5300



5900



5400



PLP - Contemporary Extended Reach Pulldown (5300)

PLP - Contemporary Extended Reach Pulldown (5400)

PLP - Contemporary Prep Size Pulldown (5900)

PLP PULLDOWN MINI-SUITES

All PLP Faucets can be "**Suited.**" Add matching accessories. Available in **two, three** and **four** piece Suites.

TRANSITIONAL PLP PULLDOWN FAUCETS AND MINI-SUITES



5700



5930



5800



PLP - Transitional Extended Reach Pulldown (5700)

PLP - Transitional Extended Reach Pulldown (5800)

PLP - Transitional Prep Size Pulldown (5930)

PLP PULLDOWN MINI-SUITES

All PLP Faucets can be "Suited." Add matching accessories. Available in **two**, **three** and **four** piece Suites.

TRADITIONAL GANTRY FAUCETS AND MINI-SUITES



GANTRY SUITES

All Gantry Faucets can be "Suited." Add matching accessories. Available in **two, three and four** piece Suites.

TRADITIONAL - Hook spout (4400)

TRADITIONAL - Articulated spout. Available in **12"** and **18"** reach models (4410-12/18)

CONTEMPORARY GANTRY FAUCETS AND MINI-SUITES



GANTRY SUITES

All Gantry Faucets can be "Suited." Add matching accessories. Available in **two, three and four** piece Suites.

CONTEMPORARY - Straight spout (3700)

CONTEMPORARY - Articulated spout. Available in **12"** and **18"** reach models (3710-12/18)

TRADITIONAL BRIDGE FAUCETS



6200
6250



ALSO AVAILABLE WITH
CROSS HANDLES



6300
6350



6100-12, 6100-18
6150-12, 6150-18



BRIDGE SUITES

All Bridge Faucets can be "Suited." Add matching accessories such as a Side Spray, Soap/Lotion Dispenser, Air Switch or Air Gap.

TRADITIONAL - Annapolis Bridge Faucet (6200, 6250)

TRADITIONAL - Hampton Bridge Faucet (6300, 6350)

TRADITIONAL - Towson Bridge Faucet (6100-12, 6100-18, 6150-12, 6150-18)

CONTEMPORARY BRIDGE FAUCETS



7825



7600-12
7600-18



7800

BRIDGE SUITES

All Bridge Faucets can be "Suited." Add matching accessories such as a Side Spray, Soap/Lotion Dispenser, Air Switch or Air Gap.

CONTEMPORARY - Fulton Bridge Faucet (7825)

CONTEMPORARY - Hunley Bridge Faucet (7600-12, 7600-18)

CONTEMPORARY - Parche Bridge Faucet (7800)



WALL MOUNTED POTFILLERS



3100



3200

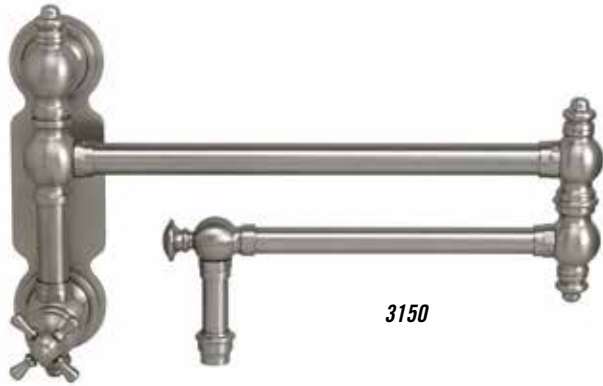

3150

TRADITIONAL - 22" Articulated spout available with lever or cross handle (3100/3150)
CONTEMPORARY - 22" Articulated spout (3200)



COUNTER MOUNTED POTFILLERS



3300



3350



3400

TRADITIONAL - 22" Articulated spout available with lever or cross handle (3300/3350)
CONTEMPORARY - 22" Articulated spout (3400)

TRADITIONAL KITCHEN FAUCETS



4200



4300



4100-12
4100-18

KITCHEN SUITES

All Kitchen Faucets can be **"Suited."** Add matching accessories such as a Side Spray, Soap/Lotion Dispenser, Air Switch or Air Gap.

ANNAPOLIS - Traditional with Hook spout (4200)

HAMPTON - Traditional with C-spout (4300)

TOWSON - Traditional with Articulated spout, available in 12" and 18" reach models (4100-12/18)



CONTEMPORARY KITCHEN FAUCETS



3825



3600-12
3600-18



3800

KITCHEN SUITES

All Kitchen Faucets can be **"Suited."** Add matching accessories such as a Side Spray, Soap/Lotion Dispenser, Air Switch or Air Gap.

FULTON - Contemporary with 2 Bend U-spout (3825)

HUNLEY - Contemporary with Articulated spout, available in 12" and 18" reach models (3600-12/18)

PARCHE - Contemporary with C-spout (3800)



TRADITIONAL TWO HANDLE KITCHEN FAUCETS



8030



8010-12
8010-18



8020



TWO HANDLE KITCHEN SUITES

All Two Handle Kitchen Faucets can be "Suited." Add matching accessories such as a Side Spray, Soap/Lotion Dispenser, Air Switch or Air Gap.

ANNAPOLIS - Traditional with Hook spout (8020)

HAMPTON - Traditional with C-spout (8030)

TOWSON - Traditional with Articulated spout, available in 12" and 18" reach models (8010-12/18)

TRADITIONAL PREP FAUCETS



4800



4900



4700

PREP SUITES

All Prep Faucets can be "Suited." Add matching accessories such as a Side Spray, Soap/Lotion Dispenser, Air Switch or Air Gap.

ANNAPOLIS - Traditional with Hook spout (4800)

HAMPTON - Traditional with C-spout (4900)

TOWSON - Traditional with Straight spout (4700)



CONTEMPORARY PREP FAUCETS



3925



3500



3900

PREP SUITES

All Prep Faucets can be "Suited." Add matching accessories such as a Side Spray, Soap/Lotion Dispenser, Air Switch or Air Gap.

FULTON - Contemporary with 2 Bend U-spout (3925)

HUNLEY - Contemporary with Straight spout (3500)

PARCHE - Contemporary with C-spout (3900)



TRADITIONAL BAR FAUCETS



- ANNAPOLIS** - Traditional with Hook spout available with **lever or cross handles** (1300/1350)
- HAMPTON** - Traditional with C-spout available with **lever or cross handles** (1500/1550)
- TOWSON** - Traditional with Straight spout available with **lever or cross handles** (1800/1850)



CONTEMPORARY BAR FAUCETS



- PARCHE** - Contemporary with C-spout (1600)
- FULTON** - Contemporary with 2 Bend U-spout (1625)
- HUNLEY** - Contemporary with Straight spout (2500)

TRADITIONAL FILTRATION FAUCETS

COLD ONLY, HOT ONLY AND HOT/COLD



1100C



1100H



1100HC



1150C



1150H



1150HC



1200C



1200H



1200HC



1250C



1250H



1250HC



1700C



1700H



1700HC



1750C



1750H



1750HC

ANNAPOLIS - Traditional with Hook spout available with **lever or cross handles** (1100/1150)

HAMPTON - Traditional with C-spout available with **lever or cross handles** (1200/1250)

TOWSON - Traditional with Straight spout available with **lever or cross handles** (1700/1750)



CONTEMPORARY FILTRATION FAUCETS

COLD ONLY, HOT ONLY AND HOT/COLD



1400C



1400H



1400HC



1425C



1425H



1425HC



1900C



1900H



1900HC

PARCHE - Contemporary with C-spout (1400)

FULTON - Contemporary with 2 Bend U-spout (1425)

HUNLEY - Contemporary with Straight spout (1900)

SIDE SPRAYS



3025



4025

CONTEMPORARY - With insulated handle (3025)
TRADITIONAL - With insulated handle (4025)

AIR SWITCHES



3010



4010



TRADITIONAL INCLUDES 2 DECORATIVE BUTTONS

CONTEMPORARY - No buttons (3010)
TRADITIONAL - Includes 2 decorative buttons "Disposer" and "Finish" Match (4010)



SOAP/LOTION DISPENSERS



4055



4060



TRADITIONAL INCLUDES 3 DECORATIVE BUTTONS



4065

TRADITIONAL - Straight spout includes a choice of 3 decorative buttons "Soap," "Lotion," and "Finish" Match (4055)
TRADITIONAL - Hook spout includes a choice of 3 decorative buttons "Soap," "Lotion," and "Finish" Match (4060)
CONTEMPORARY - Straight spout, no buttons (4065)

DECORATIVE HOLE COVERS



3080



4070



4080

CONTEMPORARY - (3080)

TRADITIONAL - Logo Button (4070)

TRADITIONAL - (4080)

AIR GAPS



3020



3030



4020



4030



TRADITIONAL
INCLUDES 2
DECORATIVE
BUTTONS

CONTEMPORARY - No buttons. Single Port (3020), Dual Port (3030)

TRADITIONAL - Includes 2 decorative buttons "Logo" and "Finish" Match. Single Port (4020), Dual Port (4030)

ESCUTCHEON PLATES



3783



3784



4783



4784

CONTEMPORARY - Decorative plate (6" plate - 3783)

CONTEMPORARY - Covers additional holes on sinks (10" plate - 3784)

TRADITIONAL - Decorative plate (6" plate - 4783)

TRADITIONAL - Covers additional holes on sinks (10" plate - 4784)

TRADITIONAL CABINET KNOBS, CABINET PULLS AND APPLIANCE PULLS



HTK-001



HTK-003



HTK-006



HTK-002



HTK-004



HTK-007



HTK-005

*HTP-0300
HTP-0350
HTP-0400
HTP-0500
HTP-0600
HTP-0800*



HTP - 1200

*HTP - 18
HTP - 24*



- TRADITIONAL KNOBS** - (HTK-001, HTK-002, HTK-003, HTK-004)
- TRADITIONAL POST AND T-PULLS** - (HTK-005, HTK-006, HTK-007)
- TRADITIONAL PULLS** - (HTP-0300, HTP-0350, HTP-0400, HTP-0500, HTP-0600, HTP-0800)
- TRADITIONAL HEAVY DRAWER PULL** - (HTP-1200)
- TRADITIONAL APPLIANCE PULLS** - (HTP-18, HTP-24)

CONTEMPORARY CABINET KNOBS, CABINET PULLS AND APPLIANCE PULLS



HCK-100



HCK-101



HCK-102



HCK-103

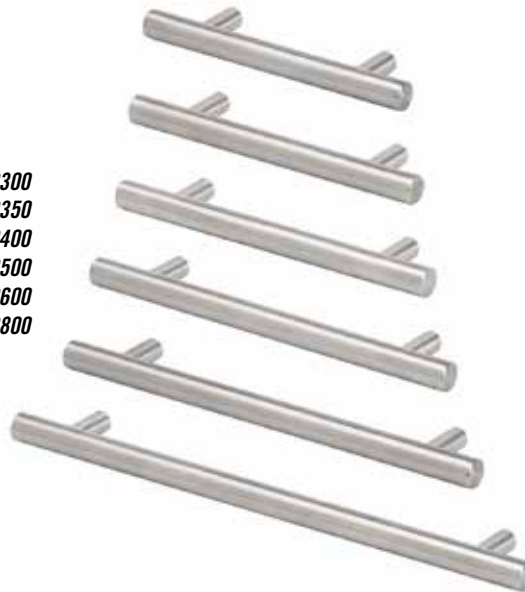

HCP-0300
HCP-0350
HCP-0400
HCP-0500
HCP-0600
HCP-0800



HCP - 1200



HCP - 18
HCP - 24

- CONTEMPORARY KNOBS** - (HCK-100, HCK-101)
- CONTEMPORARY POST AND T-PULLS** - (HCK-102, HCK-103)
- CONTEMPORARY PULLS** - (HCP-0300, HCP-0350, HCP-0400, HCP-0500, HCP-0600, HCP-0800)
- CONTEMPORARY HEAVY DRAWER PULL** - (HCP-1200)
- CONTEMPORARY APPLIANCE PULLS** - (HCP-18, HCP-24)

UNDER SINK PACKAGE SYSTEMS

ULTIMATE SYSTEM



1000

INSTA-HOT SYSTEM



2000

FILTRATION SYSTEM



3000

ULTIMATE SYSTEM - Contains #5000 Hot Tank with **PRV**, #30101 Multi-Stage Filtration System and #AS-414 Safety Valve-Leak Detector (1000)

INSTA-HOT SYSTEM - Contains #5000 Hot Tank with **PRV** and #AS-414 Safety Valve-Leak Detector (2000)

FILTRATION SYSTEM - Contains #30101 Multi-Stage Filtration System and #AS-414 Safety Valve-Leak Detector (3000)



HOT TANK, FILTRATION SYSTEM AND SAFETY VALVE-LEAK DETECTOR



5000



30101



AS-414

HOT TANK - with PRV (Pressure Regulator Valve), 2 year warranty (5000)

MULTI-STAGE FILTRATION SYSTEM - Provides **1000** gallon filtration capacity (30101)

SAFETY VALVE-LEAK DETECTOR - (AS-414)

FINISHES



GROUP ONE



AB - Antique Brass



*ABZ - Antique Bronze
(Living Finish)*



CH - Chrome



*ORB - Black Oil Rubbed Bronze
(Living Finish)*



SC - Satin Chrome



*WB - Weathered Brass
(Living Finish)*



*TB - Tuscan Brass
(Living Finish)*

GROUP TWO



AP - Antique Pewter



AC - Antique Copper



AMB - American Bronze



BLN - Black Nickel



*CB - Caribbean Bronze
(Living Finish)*



CLZ - Classic Bronze



CHB - Chocolate Bronze



DAP - Distressed Antique Pewter



DAC - Distressed Antique Copper



DAMB - Dist. American Bronze



DAB - Dist. Antique Brass



GB - Gloss Black



MB - Matte Black



PB - Polished Brass



PC - Polished Copper



PN - Polished Nickel



SB - Satin Brass



SN - Satin Nickel



VB - Venetian Bronze



*UPB - Unlacquered Polished Brass
(Living Finish)*



*WC - Weathered Copper
(Living Finish)*

STAINLESS STEEL



*SS - Stainless Steel
CONTEMPORARY ONLY*

PRECIOUS METALS



PG - Polished Gold



SG - Satin Gold

FINISHES

Our **30** finishes are divided into separate groups. Each finish has specific care instructions and can be found in the back of the *Finishes* section. They are also included with every product. For all of our finishes, we never recommend the use of any abrasive type cleaners, cloths, or pads to clean your faucet or accessory.

CLEAR PROTECTIVE COATED FINISHES

AB - Antique Brass

AC - Antique Copper

AMB - American Bronze

AP - Antique Pewter

CLZ - Classic Bronze

DAMB - Distressed American Bronze

DAB - Distressed Antique Brass

DAC - Distressed Antique Copper

DAP - Distressed Antique Pewter

PB - Polished Brass

PC - Polished Copper

SB - Satin Brass

SN - Satin Nickel

VB - Venetian Bronze

These finishes have a clear protective coating and are only considered semi-durable. If the outside clear coating is scratched or damaged in any way, the base metal finishes exposed will oxidize. Any use of an abrasive cleanser, or any abrasive pad, cloth or sponge can remove or dull the protective coating and damage the finish. Some available sink cleaners with bleach, soaps, and hand lotions will damage the finish, as can acidic organic cleansers. Always wipe your fixture down with a clean soft cloth and keep it clean and dry after use.



AP



AMB



SN



DAC



AB



PC



SB

PLATED FINISHES

BLN - Black Nickel

PN - Polished Nickel

CH - Chrome

SC - Satin Chrome

These finishes are the most durable finishes Waterstone offers. The best general maintenance is regular cleaning. Even though these finishes are considered durable, you can never use any abrasive type cleaners, cloth, or pads to clean your fixture. Always try and keep your finishes clean and dry. Trapped moisture on the surface of your finish can lead to staining. Astringent cleaners, chlorine, bleach, along with acidic based organic cleansers are potentially harmful to these finishes. Chrome plated finishes are very tarnish resistant. However, they are not indestructible and can scratch and mar.



POWDER COATED FINISHES

CHB - Chocolate Bronze

GB - Gloss Black

MB - Matte Black

These finishes are powder coated color finishes. They have **NO ADDITIONAL PROTECTIVE COATINGS** and are not considered durable finishes. They can be scratched, chipped or scuffed. If the exterior color coating is damaged, the exposed metal base will oxidize. Any use of an abrasive cleanser, or any abrasive pad, cloth or sponge can remove or dull the protective coating and damage the finish. Some available sink cleaners with bleach, soaps, and hand lotions will damage the finish, as can acidic organic cleansers. Always wipe your fixture down with a clean soft cloth and keep it clean and dry after use.



LIVING FINISHES

ABZ - Antique Bronze

CB - Caribbean Bronze

ORB - Black-Oil Rubbed Bronze

TB - Tuscan Brass

UPB - Unlacquered Polished Brass

WB - Weathered Brass

WC - Weathered Copper

These finishes are considered **Living Finishes** and have **NO PROTECTIVE COATINGS**. Living Finishes are finishes that have a very shallow patina on their surface. Essentially, the finishes are what nature would do to the surface over a long period of time. The finishes are intended to change with time. They will generally darken slightly where they are not being touched, and highlight the high use points on the fixture. Hand oils, soaps, acidic fluids and cleaners can damage the finish. These finishes are not durable and can be easily scratched or scuffed. Any type of astringent cleaner or type of abrasive cleanser, pad, cloth or sponge will damage the finish. To help keep the surface on the fixture from oxidizing, Waterstone initially applies a wax to the surface to help protect and prevent the finish from exposure to air and oxidizing prior to installation.

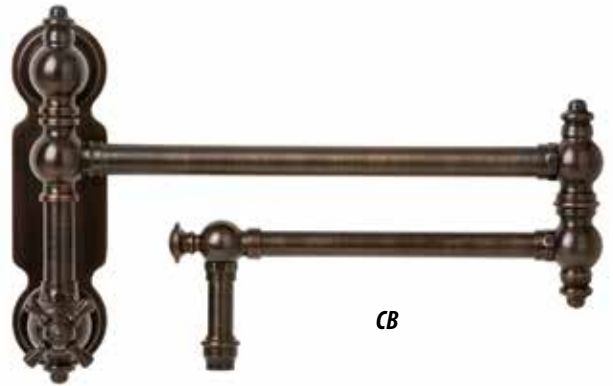

CB



WC



WB



ORB



TB



ABZ

SOLID STAINLESS STEEL - CONTEMPORARY ONLY

SS - Stainless Steel

Waterstone's stainless steel fixtures are actually made of solid 316 Marine Grade Stainless Steel. This finish has **NO PROTECTIVE COATING** on it. Stainless steel is by its material nature are very tarnish resistant, but are not tarnish or stain proof. This finish will indeed oxidize naturally over time and react to its environment and in reaction to Some chemical cleaners that have bleach could cause a reaction and induce rusting to the finish. Keep your stainless fixture wiped clean and dry, and use only a cleaner specifically made for stainless steel. Trapped moisture on the surface of your finish can lead to staining. Astringent cleaners, chlorine, bleach, along with acidic based organic cleansers are potentially harmful to stainless steel finishes.

PRECIOUS METALS

PG - Polished Gold

SG - Satin Gold

This finish is done with real precious metal gold plating on the brass fixture surface. This finish has **NO PROTECTIVE COATINGS** and is extremely soft. Some or all of the Gold plating will be removed if any type of polish is used. Additionally, the finish will wear away with time. The gold plating is considered very delicate and can be easily scratched or scuffed. Any type of astringent cleaner or any type of abrasive cleaner, pad, cloth or sponge will damage the finish. Finishes in gold (either polished or satin) are commodity metal finished. There is no regular list price for these finishes. You must call the Waterstone Customer Service Department and obtain a quote for theses finishes.



SS